

EOS-3



EYE CONTROL



English Edition
INSTRUCTIONS

The image was removed due to
copyright restrictions

Thank you for purchasing a Canon product.

The EOS-3 is the world's first high-performance AF single-lens reflex camera with Eye-Control area AF. The camera's many features can suit diverse picture-taking requirements from fully automatic operations to highly specialized applications. It also retains the simple electronic dial operation found on other top-tier EOS cameras.

Before using the camera, read this Instructions booklet and familiarize yourself with the camera.

● Precautions

- Before using the camera for important events such as a weddings, be sure to take test shots to make sure the camera operates properly.
- EOS cameras have a lens mount fitted with electrical contacts for dedicated operation (autofocusing, exposure control, etc.) with Canon EF lenses. Using a non-EF lens with an EOS camera may not result in proper camera or lens operation.
Also, the warranty does not cover any malfunction or damage occurring with the use of non-Canon lenses.

● Symbols used in this Instructions booklet:

- ⚠ : Warning for preventing camera malfunction.
- 📖 : Supplementary notes for basic camera operation.
- 💡 : Helpful tip for operating your camera and taking pictures.
- Page numbers in parentheses indicate where you can find more information.
- Also read "Handling Precautions" on page 6 to prevent faulty pictures and camera mishaps.
- Retain this Instructions manual for future reference.

Contents

	Handling Precautions6 Nomenclature9
Before You Start	1. Basic Operation16 2. Installing the Battery and Checking the Battery Level21 3. Mounting and Detaching a Lens ..23
Quick Start With Program AE	Program AE30 Shifting the Program31
Autofocus (AF)	1. AF Mode Selection34 AF Modes35 2. Area AF Ellipse and Focusing Points37 3. Focusing Point Selection38 ● Automatic Selection38
Metering Modes	1. Selecting a Metering Mode54 2. Metering Modes55 Evaluative Metering ()55
Shooting Modes	1. Shutter Speed-Priority AE (Tv): You Set the Shutter Speed62 2. Aperture-Priority AE (Av): You Set the Aperture65 3. Depth-of-field AE (DEP): You Set the Depth of Field68 Depth-of-field AE with a Manually- Selected Focusing Point68 Depth-of-field AE with Eye-Selected Focusing Points70
Flash Photography	1. Flash Photography with Speedlite 550EX92
Custom Functions	1. Setting and Canceling Custom Functions104
Reference Section	1. Troubleshooting Guide128 2. Exposure Warning List130 3. Program Line131

Conventions Used in this Instructions Booklet.....13	Attaching the Strap.....14
4. Loading Film24 Setting the Film Speed26	5. Unloading Film28 Midroll Rewind (Q).....28
Dioptric Adjustment Lenses32	
● Manual Selection38 ● Eye-Control Selection38 About Eye-Control AF41 Eye-Control Calibration.....42 4. Eye-Control One-Shot AF Mode..47 5. Eye-Control AI-Servo AF Mode ...48	6. Focusing an Off-Center Subject ..49 ● AF Sensitivity and the Lens' Maximum Aperture.....50 7. When Autofocus Fails51 8. Manual Focusing52
Partial Metering (☒).....55 Spot Metering (☐).....55 Centerweighted Metering (☐).....56	Focusing Point-Linked Spot Metering56 Multi-Spot Metering.....57
4. Manual Exposure (M): You Set the Shutter Speed and Aperture73 5. Setting Exposure Compensation...75 6. Autoexposure Bracketing (AEB)77 Canceling AEB.....78 7. AE Lock79 8. Setting the Film Speed Manually...81 9. Multiple Exposures (☑).....82	10. buLb Exposures84 11. Switching the Film Advance Mode85 12. Self-timer Operation.....87 Attaching the Eyepiece Cover88 13. Mirror Lockup89 14. Depth-of-field Preview90 15. LCD Panel Illumination90
2. Using Other EOS-Dedicated Speedlites100	3. Using Non-Canon Flash Units ...101
2. Custom Function Settings.....106	3. Index of Custom Functions124
4. Shutter Speed and Aperture Readouts132 5. Interchanging the Focusing Screen.....133	6. Major Accessories135 Major Specifications140 Custom Function Symbols145

Handling Precautions

Camera Care and Storage

- (1) The camera is a precision instrument. Do not drop it or subject it to physical shock.
- (2) This camera is not waterproof and cannot be used underwater. If the camera gets really wet, promptly consult your nearest Canon Service Center. Wipe off any water droplets with a dry cloth. If the camera has been exposed to salty air, wipe with a well-wrung damp cloth.
- (3) Do not leave the camera in places prone to excessive heat such as in a car on a sunny day. Excessive heat can cause the camera to malfunction.
- (4) The camera contains precision electronic circuitry. Never attempt to disassemble the camera.
- (5) Use only a blower brush to blow away dust on the lens, viewfinder eyepiece, focusing screen, film compartment, and mirror. Do not use an organic solvent-containing cleaner to clean the camera body or lens. For stubborn dirt, consult your nearest Canon Service Center.
- (6) The shutter curtains are extremely thin. Use only a blower to clean. Be careful not to blow air too forcefully on the shutter curtains. The shutter curtains can be easily deformed or damaged. Also, when loading and unloading film, be careful not to touch the shutter curtains.
- (7) Do not touch the electrical contacts with your fingers. Otherwise corrosion may develop on the contacts, resulting in improper camera operation.
- (8) If the camera is not to be used for an extended period, remove the battery. Store the camera in a well-ventilated, cool, dry place. During the storage period, release the shutter a few times once in a while.
- (9) Avoid storing the camera in a laboratory, cabinet, etc., where corrosive chemicals are present.
- (10) If the camera has not been used for an extended period or if the camera is to be used for an important event, check the operation of all the camera controls or take it to your nearest Canon Service Center.

- (11) After detaching the lens from the camera, put on the lens caps or put down the lens with the rear end up to avoid scratching the lens surface and electrical contacts.
- (12) Even when the Main switch is set to <■>, a small amount of power is still supplied to the camera's LCD panel. However, this does not affect the number of film rolls which can be taken with the battery.

LCD Panel

In time, the camera's LCD (liquid-crystal display) panel indications may become light and difficult to read. If this happens, have it replaced (at cost) by a Canon Service Center.

At low temperatures, the display response of the LCD panel may become slower. And at 60°C or higher temperatures, the display may blacken. In either case, the display will return to normal at room temperature.

Blinking "bc" on the LCD panel

If the battery power falls to a very low level or a camera misoperation or malfunction occurs, "bc" will blink on the LCD panel. In such a case, follow the procedure below:

- (1) Press the battery check button to check the battery power. If the battery power is low, replace the battery.
- (2) If the battery power is normal, remove the battery and reload it.
- (3) Release the shutter once.

If the "bc" then turns off, the camera is back to normal. However, if this procedure is repeated and "bc" still continues to blink, the camera has a malfunction. Take it to your nearest Canon Service Center.

About the Battery

The camera operates only after the battery is properly installed (see page 21). Check the battery power in the following cases:

- (1) After replacing the battery.
- (2) After not using the camera for an extended period.
- (3) The shutter does not work.
- (4) The camera is being used in a low-temperature environment.
- (5) Before using the camera for an important event.
 - Before installing the battery, wipe the battery contacts to remove any fingerprints and smudges. This is to prevent faulty connections and corrosion.
 - Never disassemble or recharge the battery. Also, never store a battery in high-temperature places or short circuit the battery contacts or toss a battery into a fire.
 - Although lithium batteries work well even in low temperatures, battery performance may suffer slightly in freezing temperatures. In such a case, keep a spare battery warm in a pocket, etc., and use and warm the batteries alternately.

Low Battery Power

Even when **bc** is not displayed or when it blinks on the LCD panel, a correctly-exposed picture can still be taken as long as the shutter can be released. However, when the battery power runs out, there may not be enough power to advance and rewind the film automatically. "**bc**" will then blink on the LCD panel. After the battery is replaced with a new one, film advance will resume automatically or film rewind will continue when the midroll film <  > is pressed.

Nomenclature

- Reference page numbers are indicated in parentheses.
- In the text, camera controls are indicated by their respective icons.

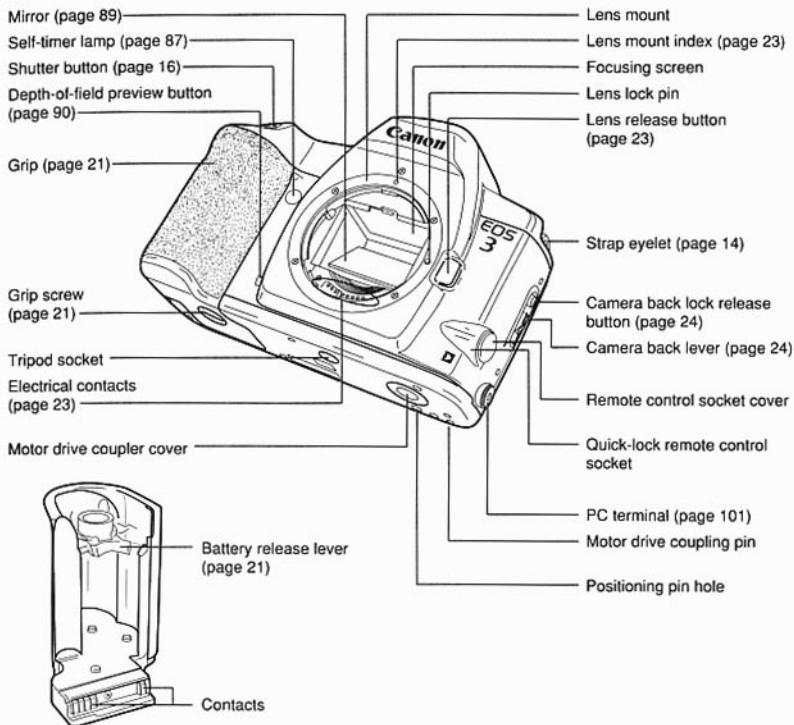

Nomenclature

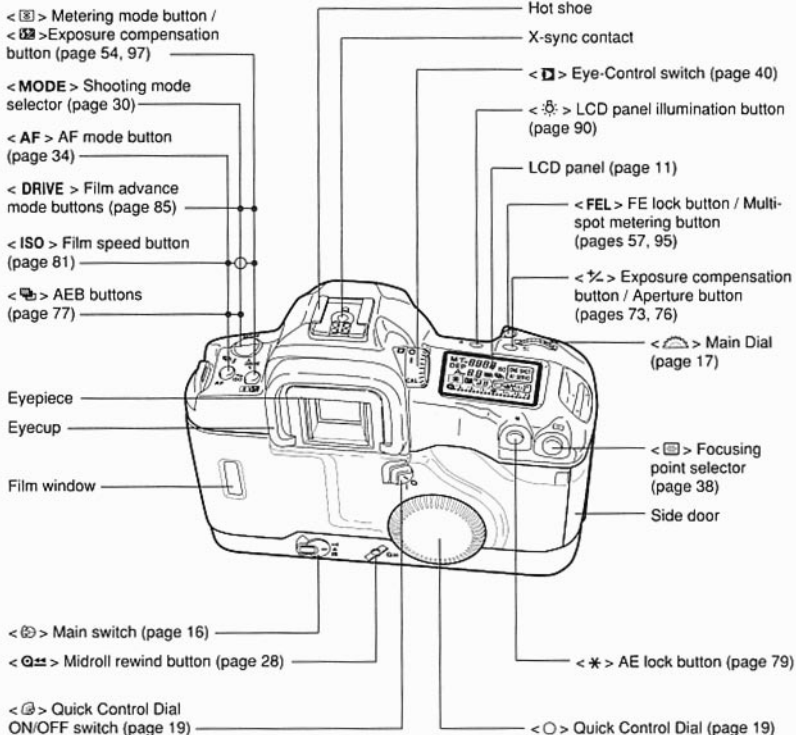

Side Door Buttons

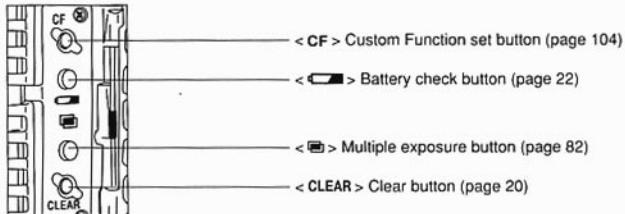

LCD Panel

- On the LCD panel, the display boxes are colored to match the color of the camera controls.

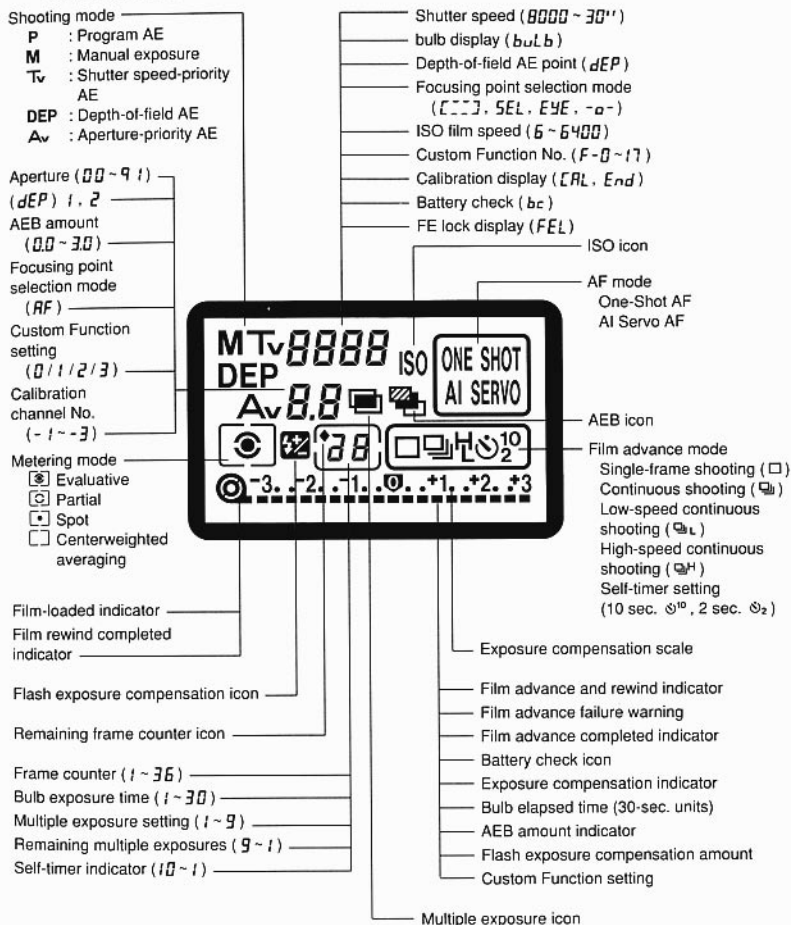

Viewfinder Information

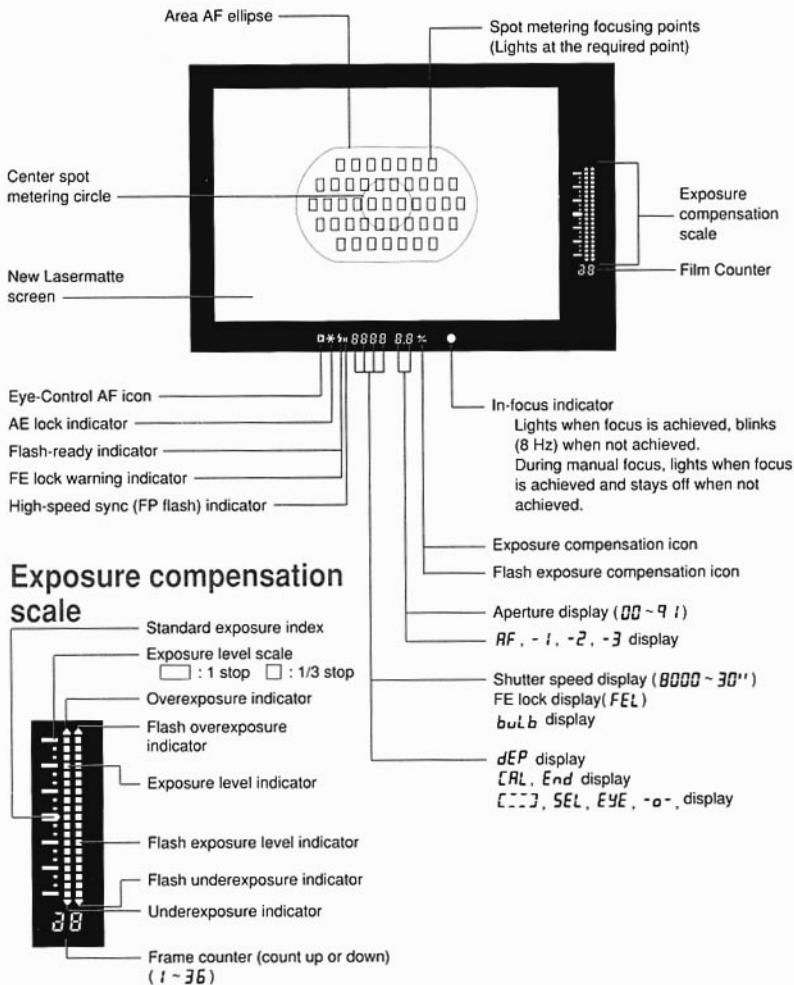

Conventions Used in this Instructions Booklet

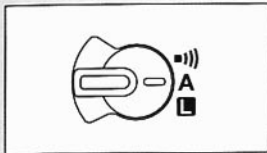

- All the operations described in this booklet assume that the <☀> switch is already set to <A>. Before proceeding with any operation, first turn the <☀> switch to <A> or <☀>.

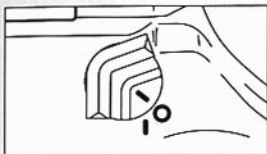

- For <☀> dial operations, make sure the <☀> switch is set to <I>.

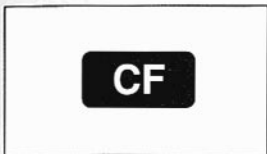

- This symbol is used to indicate that there is a related Custom Function. For details, see "Custom Functions" on page 111

- In the text, the <☀> icon indicates the Main Dial, <☀> indicates the Quick Control Dial, <☀> indicates the main switch, and <☀> indicates the Quick Control Dial switch.
- The camera control icons and markings used in the text correspond to the actual icons and markings found on the camera. The correct name of the button or setting indicated by the icon or marking can be found in "Nomenclature" on page 9. Reference page numbers are also stated in parentheses.
- In these Instructions, a Canon EF 50mm f/1.4 USM lens is used for explaining the procedures.
- The procedures are based on the pretense that the Custom Functions are set to the default settings.

- The (⌚6) icon indicates that the respective function or setting remains effective for 6 seconds after you take off your finger from the shutter button.
- The (⌚16) icon indicates that the respective function or setting remains effective for 16 seconds after you take off your finger from the shutter button.

Attaching the Strap

Pass the end of the strap through the camera's strap eyelet and the strap's clasp on the under side. Pull the strap to make sure it does not slip out of the clasp.

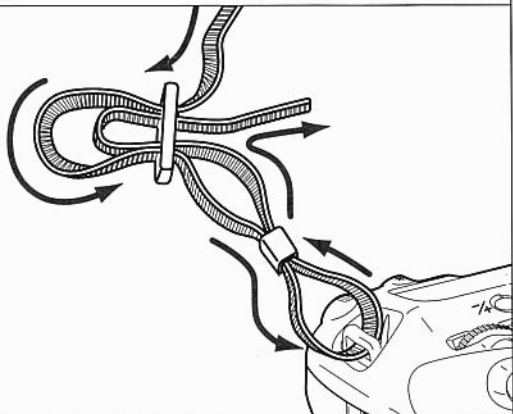

Before You Start

This chapter explains a few preliminary steps and basic operations which you should know before you start taking pictures. If you are a new EOS user, read this chapter first.

If you are familiar with the basic operations of EOS cameras and want to start using the camera right away, see “Quick Start with Program AE” on page 29.

1. Basic Operation

Main Switch

The camera operates only after the <Ⓛ> switch is turned on. This main switch has three settings:

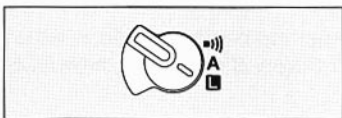

<Ⓛ>: Lock position. The camera does not operate. Set to this position when not using the camera.

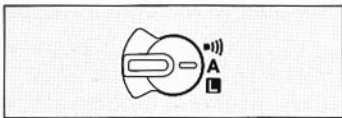

<A>: To turn on the camera, set to this position. The "A" stands for "Advance."



<•••>: This is the same as <A> except that it also enables the beeper to sound in the following cases:

- Focus is achieved in One-Shot AF mode.
- Focus is achieved with manual focus.
- During Eye-Control calibration.
(Short beeps for successful registration and intermittent beeping for failed registration.)



When the camera is not to be used, set the Command Dial to <Ⓛ>. This will prevent accidental battery drainage if the shutter button is held down inadvertently.

Shutter Button

You can press the shutter button halfway or all the way.

Hold the camera steadily and press the shutter button slowly without any jerking movement. The difference between halfway and complete pressing of the shutter button is explained below. Beginners should practice pressing the shutter button halfway and completely before loading any film.

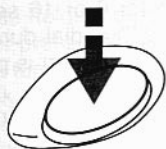

(1) Halfway pressing

When the shutter button is pressed halfway, autofocus (AF) is activated to focus the subject. Autoexposure (AE) metering is also turned on to set the correct shutter speed and aperture which is displayed in the viewfinder and on the LCD panel for (6).



(2) Complete pressing

This releases the shutter and takes the picture. After the frame is exposed, the camera advances the film automatically.

Using the Electronic Dials

There are three ways to use the <⚙> dial:



1. Press and hold down a button and turn the <⚙> dial while looking at the LCD panel. When the button is released, you can take a picture.

① Hold down a button...

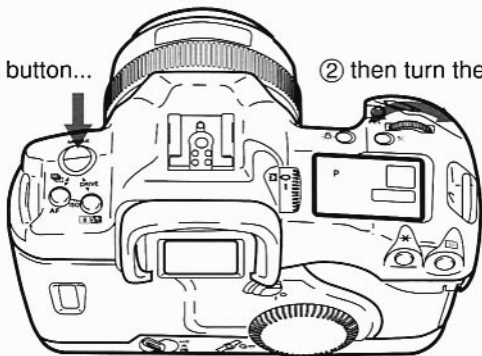
② then turn the <⚙>.



Basic Operation

2. After pressing a button, turn the  dial.
When a button is pressed, its function turns on for 6 or 16 seconds. You then look at the LCD panel and turn the  dial during this time. After the function turns off or when the shutter button is pressed halfway again, the camera will be ready to take a picture. Buttons which turn on for 6 or 16 seconds are indicated in these Instructions with the following icons:

(6): The button's function remains active for 6 seconds after the button is released.

(16): The button's function remains active for 16 seconds after the button is released.

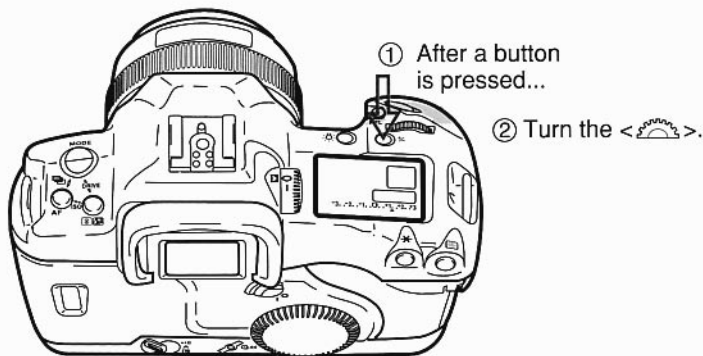

3. Just turn the  dial.
While looking at the LCD panel, you can set the shutter speed, aperture, or another setting.

There are two ways to use the <○>:

1. While holding down a button, turn the <○> dial.
2. After pressing and releasing a button, turn the <○> dial.
3. Just turn the <○> dial.
 - Look at the LCD panel to confirm the setting.
 - To restore the button's function or to ready the camera for picture taking, turn the <☀> dial.

The <○> is used to set the following:

1. Real-time exposure compensation
2. Aperture
3. Flash exposure compensation
4. Selection of a focusing point above or below

The <○> dial functions only when the <☞> switch is set to < | >.

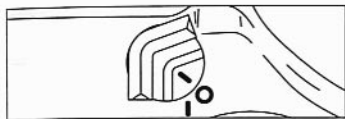

O : Set to this position to disable the <○>.



I : Set to this position to enable the <○>.

Reverting to the Default Settings

With the EOS-3, you can set the shooting mode, metering mode, and other settings as you wish. You can also use Custom Functions (see page 103) to customize camera controls and functions according to your preferences. These preferences can be reset to the default settings with the following procedure.

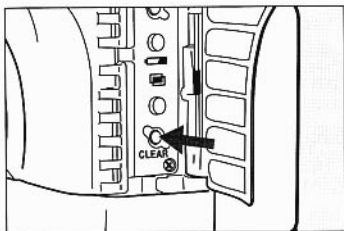

To reset the camera to the default settings:

- 1 Open the side door and press the **<CLEAR>** button. This resets the camera to the default settings shown in the table below.

Shooting mode	P
AF mode	One-Shot AF
Metering mode	Evaluative
Film advance mode	Single
Focusing point selection	Automatic
Multiple exposures	Canceled
Exposure compensation	0
Flash exposure compensation	0
AE lock	Canceled
FE lock	Canceled
AEB	Canceled
Custom Functions	Settings retained



- When the camera is reset, the shooting mode will be set automatically to Program AE **<P>** (page 29).

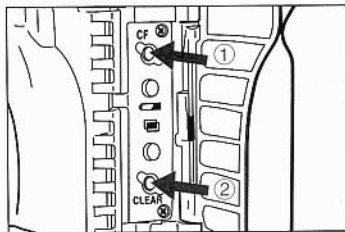

To reset all Custom Functions (except CF-0 described on page 105) to the default settings, follow the step below:

- 2 Open the side door, press the **<CF>** button, then press the **<CLEAR>** button.

2. Installing the Battery and Checking the Battery Level

The battery is housed in the camera grip. Remove the grip to install one 2CR5 lithium battery.

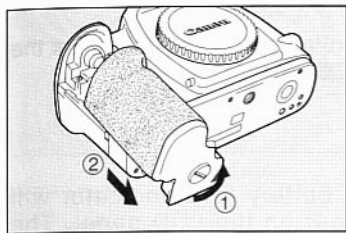

Installing the Battery

- 1 Loosen the grip screw by turning it counterclockwise as shown in the figure.
- 2 Slide the grip downward to remove.
- 3 Insert the battery so that its contacts touch the grip's contacts at the bottom.

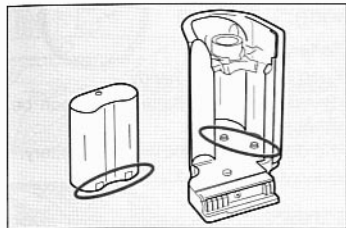

- 4 After inserting the battery, turn the battery as shown by the arrow in the figure.

- To take out the battery, slide the battery release lever.

- 5 Reattach the grip to the camera, then turn the grip screw to tighten securely.

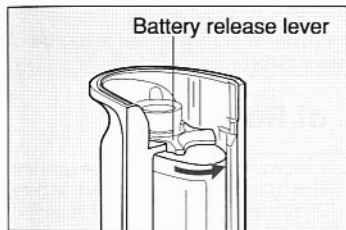

 Lithium batteries may not be available in certain areas. Carry a spare battery when going on a trip or when you will use many rolls of film.

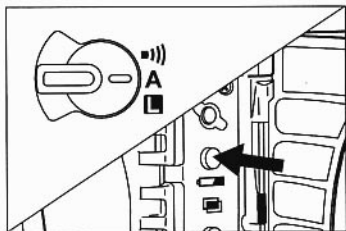

Checking the Battery Level

- 1 Set the switch to <A>.
- 2 Open the side cover and press the button.

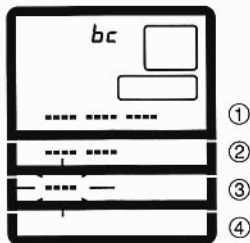

- 3 The battery level indicator will appear on the LCD panel. The different indicators indicate the following:

- ① : Battery level OK.
 - ② : Keep spare battery handy.
 - ③ : (Blinking display) Battery will soon be exhausted.
 - ④ : (No display): Replace with new battery.
- bc (blinking): See page 7.



- If the switch is set to <A> and nothing is displayed on the LCD panel, the battery is probably installed incorrectly. Install the battery correctly and check the battery level.
- Even if the conditions described in 3 and 4 apply, a proper exposure will be obtained as long as the shutter releases to take a picture.

2CR5 Lithium Battery Life (No. of Rolls)

Temperature	Rolls
+20 °C	75 (50)
-20 °C	18 (12)

- The table shows the number of 24-exposure rolls based on Canon's tests with a new battery and an EF 50mm f/1.4 USM lens. Figures in parentheses are the number of 36-exposure rolls.



- Pressing the shutter button halfway and activating the autofocus will still consume battery power even if no pictures are taken.
- Since field conditions may differ, the actual number of rolls may be less than the figures in the table.
- Pressing the shutter button halfway for prolonged periods or frequent playing with the autofocus without taking any pictures will lower the number of rolls that can be taken.

3. Mounting and Detaching a Lens

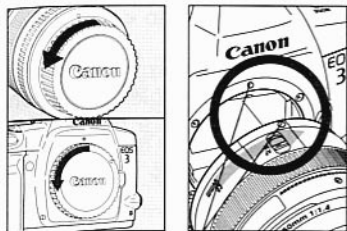

Red dots

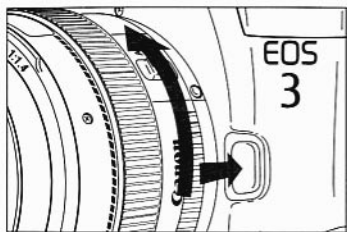
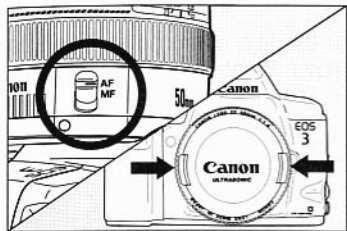

Mounting a Lens

- 1 Remove the rear lens cap and the camera body cap by turning them as shown by the arrow.
- 2 Align the red dots on the lens and camera and turn the lens as shown by the arrow until it snaps in place.
- 3 On the lens, set the focus mode switch to AF.
 - If the focus mode switch is set to MF) or M on older lenses, autofocus will not operate.
- 4 Remove the front lens cap.

Detaching the Lens

While pressing the lens release button, turn the lens as shown by the arrow until it stops. Then remove the lens.



To avoid getting the lens surface and electrical contacts scratched, attach the rear lens cap to the detached lens or always put down the lens with the rear end up.



AF stands for autofocus.

4. Loading Film

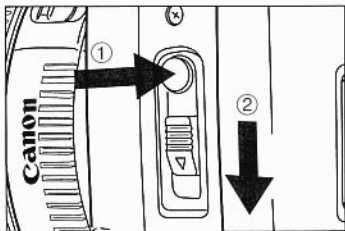

1 Set the <A> switch to <A>.

2 Use your thumb to press the camera back lock release button and slide the camera back lever down as shown by the arrow to open the camera back.

- If this is difficult to do with one finger, use one finger to press the lock release button and another finger to slide down the lever.

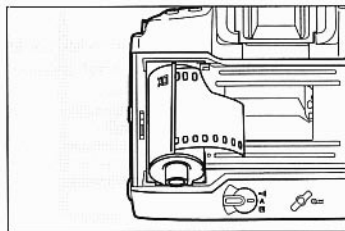

3 Insert the film cartridge at an angle as shown in the figure.

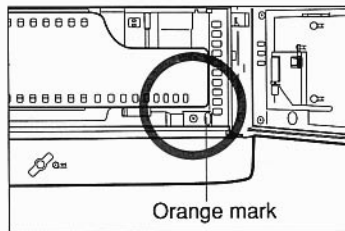

4 Hold down the film cartridge and pull the edge of the film leader to the orange mark on the camera.



- The shutter curtain is manufactured with very high precision. Never touch the shutter curtain. When loading or unloading film, be careful not to touch the shutter curtain with your fingers or the film.
- The camera back will have a protective plastic sheet on the inside. Be sure to remove this before loading film for the first time.

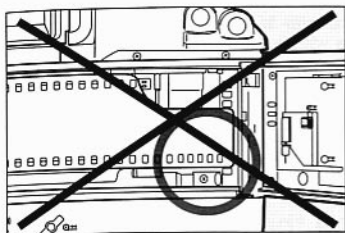

Wrong

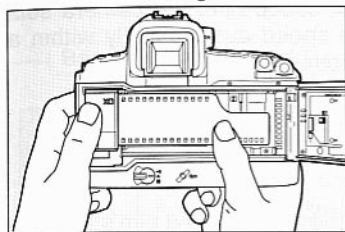

- 5** After checking that the film leader edge is correctly aligned with the orange mark, close the camera back.

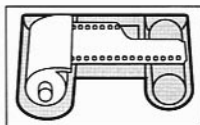

Right

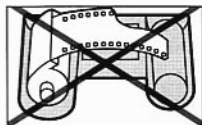

Wrong

- If the edge of the film leader goes beyond the orange mark, rewind some of the film back into the cartridge.

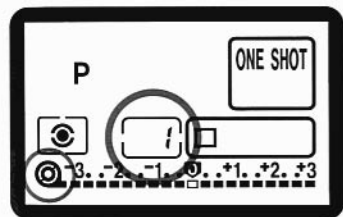

- 6** When you close the camera back, the film will advance to frame 1 automatically. The film-loaded indicator on the LCD panel will appear. "i" will also be displayed on the frame counter on the LCD panel and below the exposure compensation scale in the viewfinder.

- If the film is not loaded properly, the film advance/rewind indicator will blink and the shutter will not work. Reload the film properly.

CF

Custom Function CF-8 can set the frame counter to count down the remaining number of exposures. If this function is set, \blacklozenge will be displayed on the upper left of the frame counter on the LCD panel. See page 112.



When using the camera in high temperatures, do not remove the film packaging until you are ready to load the film.

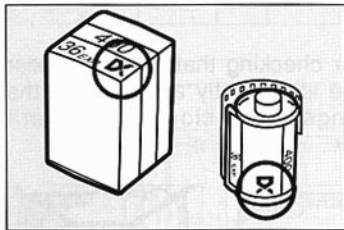

Setting the Film Speed

With DX-coded film, the camera sets the film speed automatically within a range from ISO 25 to 5000.



- To check the loaded film's ISO film speed, press the **<AF>** button and **<ISO>** button simultaneously. The ISO icon and film speed will be displayed on the LCD panel.
- If the film is not DX-coded, the LCD panel will display the following:
 - (1) The ISO icon and previous film speed will be blinking. Set the film speed by following "Setting the Film Speed Manually" on page 81.
 - (2) If Custom Function CF-8 has been set to count down the remaining frames on the frame counter, \blacklozenge will be displayed and "35" will blink on the frame counter. The frame counter counts down each time a picture is taken (the number keeps blinking).



To set a film speed different from the film's ISO speed, see "Setting the Film Speed Manually" on page 81.

CF Custom Function CF-3 can prevent the ISO film speed from being set automatically. See page 108.



Since an infrared sensor is used to detect the film's transport, it will fog (expose) infrared film below the picture area.

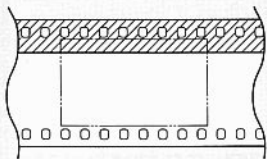

Basic Terminology 1

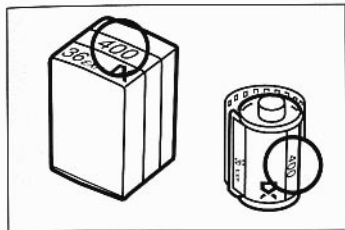



● ISO film speed

The ISO film speed indicates the film's sensitivity to light. The higher the film speed, the more sensitive the film is. The more sensitive the film is, the less light is required to obtain a standard exposure. Therefore, a high-speed film is suited for low-light situations. The ISO film speed is standardized by the International Standards Organization (ISO). The EOS-3 can display a film speed from 6 to 6400.

5. Unloading Film

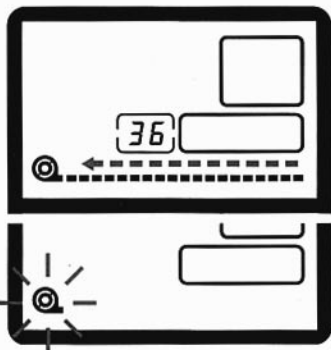
After the film's last frame is exposed, the camera rewinds the film automatically.



- 1 When the film starts to rewind, the film advance and rewind indicator (exposure compensation scale) on the LCD panel will “flow” from right to left to indicate that the film is rewinding. The frame counter also counts in reverse.
- 2 The film rewind ends automatically. Check that the  icon on the LCD panel is blinking, then remove the film cartridge.

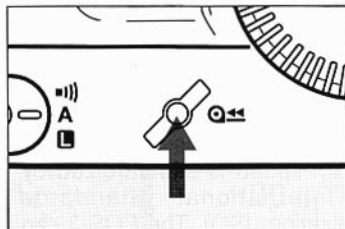

Midroll Rewind ()

To rewind the film in midroll, press the  button. The film will start rewinding immediately.



During film rewind, pressing the  button switches between high-speed and low-speed (quiet) rewind.



Custom Function CF-1 can alter the rewind speed and method. See page 106.



Normally, the entire film leader is rewound inside the film cartridge. Custom Function CF-2 can leave out the film leader after film rewind. See page 108.

Quick Start With Program AE

For quick and easy picture-taking, use the Program AE mode. This mode sets both the shutter speed and aperture automatically to suit the subject's brightness. Anyone can easily take pictures in this mode. By using the focusing points in the wide area AF ellipse in the viewfinder, it is easy to compose and capture a variety of subjects.

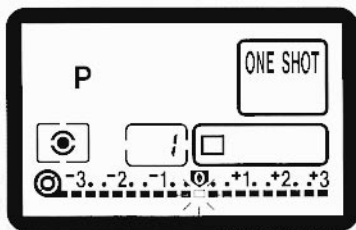

First set the <A> switch to <A>. If necessary, also set the <I> switch to <I>.



The Program AE mode is set automatically as the camera's initial shooting mode. See page 19.



AE is an abbreviation for Auto Exposure.

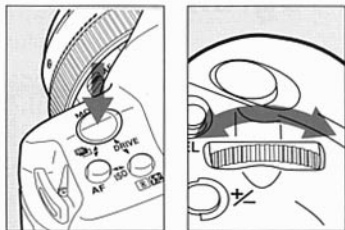

- 1 While pressing the **<MODE>** button, turn the **<P>** dial to **<P>**.

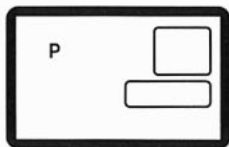

- 2 After **<P>** appears on the LCD panel, release the **<MODE>** button.

- 3 Look through the viewfinder and cover the area AF ellipse over the subject. Then press the shutter button halfway.

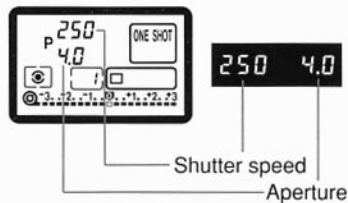
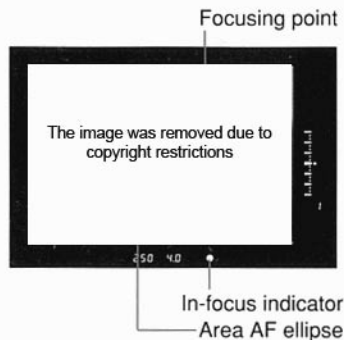

- The focusing point which achieves focus flashes in red briefly. At the same time, the in-focus indicator in the viewfinder lights in green ●.
- If the in-focus indicator in the viewfinder blinks, the shutter will lock and a picture cannot be taken. See "Manual Focusing" on page 52.
- The shutter speed and aperture will be displayed on the LCD panel and in the viewfinder.
- Do not touch the part of the lens which moves while it autofocuses.

- 4 Make sure the shutter speed and aperture are not blinking, then press the shutter button completely to take the picture.



The focusing point which achieves focus flashes in red briefly. If the focusing point has been selected manually (see page 38), it lights dimly while it is active for (Ⓞ6).

[Exposure Warnings]



If the shutter speed or aperture blinks, it means a standard exposure cannot be obtained. Although the picture can be taken, it may come out too light or too dark. For details, see "Exposure Warning List" on page 130.

Shifting the Program

In the Program AE mode <P>, you can freely change the shutter speed and aperture combination (program) set by the camera while retaining the same exposure value. This is called shifting the program.

To shift the program, press the shutter button halfway and turn the <> dial until the desired shutter speed or aperture is displayed.



The program shift setting is canceled after the picture is taken.



To obtain sharp pictures, hold the camera still to minimize camera shake.

- Firmly grasp the camera grip with your right hand.
- Hold the lens with your left hand.
- Press the camera against your face and look through the viewfinder.
- To maintain a stable stance, place one foot in front of the other instead of lining up both feet.

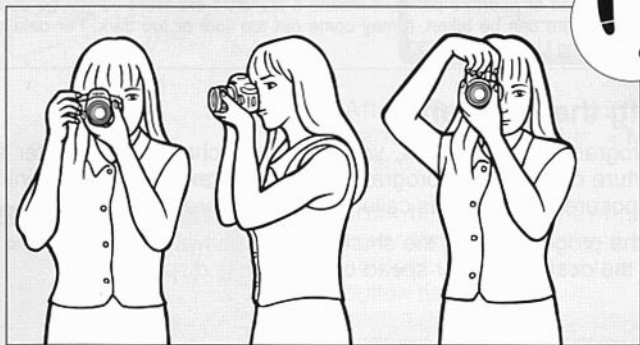

Dioptric Adjustment Lenses

By attaching a dioptric adjustment lens on the viewfinder eyepiece, near- or far-sighted users can look through the viewfinder without eyeglasses. The camera viewfinder is set to -1 diopter, and ten dioptric adjustment lenses are available. When selecting a dioptric adjustment lens, first attach it to your camera and check that it is the proper one before purchasing. See page 138.

- The EOS-3 is compatible with Ed-series dioptric adjustment lenses.

Autofocus (AF)

The area AF ellipse has 45 focusing points. By selecting the optimum focusing point, autofocusing can be executed while you maintain the desired subject framing. You can also set the AF mode to suit the subject or intended effect.

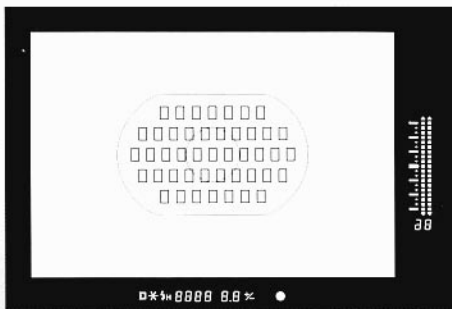

All 45 focusing points are not displayed at one time.



First set the <A> switch to <A>. If necessary, also set the <I> switch to <I>.

1. AF Mode Selection

AF Mode Selection

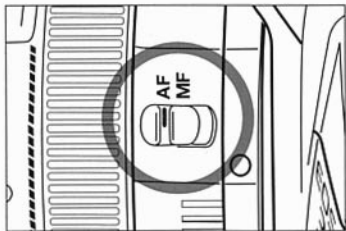

- 1 Set the lens focus mode switch to **AF**.

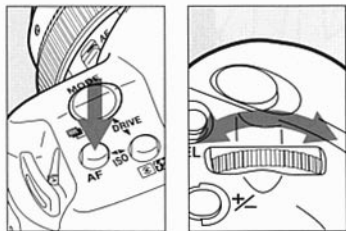

- 2 While pressing the camera's **<AF>** mode button, turn the **<⚙>** dial until the desired **<AF>** mode is displayed on the LCD panel.

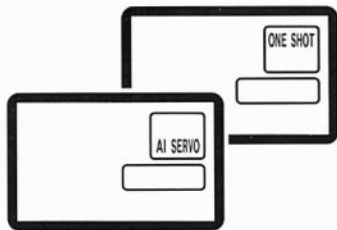

- 3 Release the **<AF>** mode button.

AF Modes

Different AF modes have different AF operation characteristics. The camera has two AF modes: One-Shot AF for still subjects, and AI Servo AF for moving subjects. (AI is an abbreviation for Artificial Intelligence.) Select the AF mode which suits the subject.

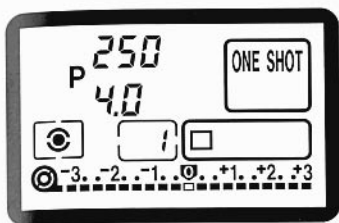

One-Shot AF for Still Subjects

Pressing the shutter button halfway activates AF operation and achieves focus.

- The focusing point which achieves focus flashes briefly and the in-focus indicator (●) in the viewfinder lights at the same time.
- When the <[AF-ON]> switch is set to <[AF-ON]>, the beeper also sounds when focus is achieved.
- With evaluative metering, the exposure setting (shutter speed and aperture) will be set when focus is achieved. The exposure setting and focus will be locked as long as the shutter button is pressed halfway. You can then recompose the shot while retaining the exposure setting and point of focus. See page 49.

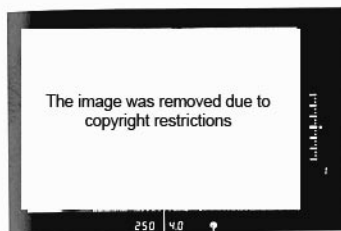

In-focus indicator
Focusing point



If focus cannot be achieved, the in-focus indicator in the viewfinder will blink. If this occurs, a picture cannot be taken even if the shutter button is pressed completely. Reframe the shot and focus again. Also see "Manual Focusing" on page 52.

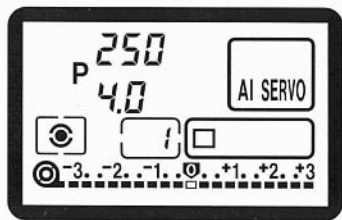

AI Servo AF for Moving Subjects

While you press the shutter button halfway, the camera focuses continuously. This AF mode suits moving subjects. With predictive AF, the camera can also focus track a subject which steadily approaches or retreats from the camera. The exposure settings are set immediately before the picture is taken.



- In the AI Servo AF mode, the viewfinder's in-focus indicator does not light and the beeper does not sound even when focus is achieved.
- If the viewfinder's in-focus indicator blinks, focus cannot be achieved.
- The focus cannot be locked (except when Custom Function CF-4 is set to 2.)

* About Predictive AF

If the subject approaches or retreats from the camera at a constant rate, the camera tracks the subject and predicts the focusing distance immediately before the picture is taken. This is for obtaining correct focus at the moment of exposure.

When focusing point selection is automatic, the camera first uses the center focusing point to focus. If the subject later moves away from the center focusing point, focus tracking continues as long as the subject is covered by another focusing point in the area AF ellipse. The active focusing point does not light.



With Custom Function CF-4, you can lock the focus momentarily by pressing the < * > button even while the AI Servo AF is active. See page 108.



Custom Function CF-11 enables you to turn the < O > dial to change the focusing point to track the subject in the AI Servo AF mode. See page 116.

2. Area AF Ellipse and Focusing Points

The area AF ellipse is an area where the subject is focused. The area AF ellipse has 45 focusing points, making AF possible over a wide area in the viewfinder. You can concentrate on composing the picture without worrying about whether a focusing point is covering the subject. As long as the subject is within the area AF ellipse, the camera will focus the subject automatically.

Focusing points in the area AF ellipse
(The focusing points do not light up all at once.)

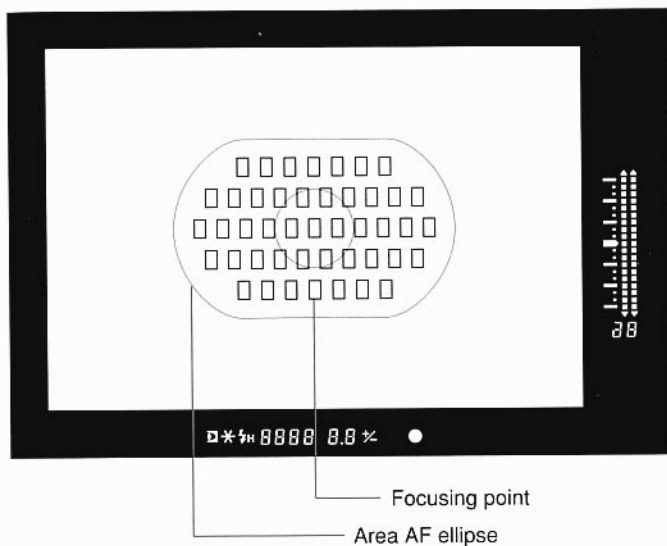

3. Focusing Point Selection

The focusing point is selected in one of three ways:

● Automatic Selection

The camera selects the focusing point automatically to suit the situation.

● Manual Selection

You select one of the 45 focusing points manually.

● Eye-Control Selection

You select a focusing point by looking at it in the area AF ellipse.

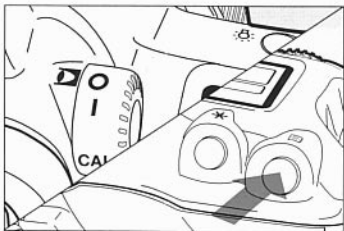

Focusing Point Selection

1 Set the **<AF-ON>** switch to **<O>**.

2 Press the **<AF-ON>** button. (06)
• The current focusing point lights.

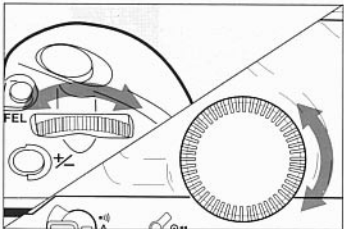

3 Turn the **<AF-ON>** and/or **<AF-ON>** dial to select the desired focusing point.

• The **<AF-ON>** dial selects a focusing point on the left or right.

The **<AF-ON>** dial selects a focusing point toward the top or bottom.

CF

Custom Function CF-17 expands the number of focusing points made available for manual focusing point selection. See page 120.

● Using the < > dial to select a left or right focusing point

Automatic Selection



- When the dial is turned, the selected focusing point shifts in the following loop: Automatic selection ↔ Left ↔ Center ↔ Right ↔ Automatic selection.
- This loop applies to all focusing point rows.

● Using the < > dial to select an upper or lower focusing point.

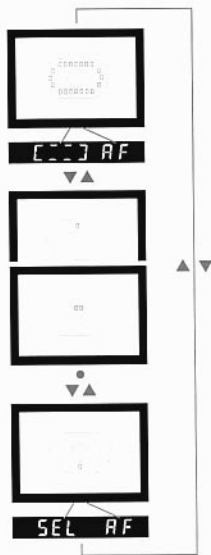

- When the dial is turned, the selected focusing point shifts in the following loop: Automatic selection ↔ Up ↔ Center ↔ Down ↔ Automatic selection.
- As shown in the figures, the focusing point selection shifts from single (□) to double (□□) to single (□) focusing point(s).
- This loop applies to all focusing point columns.



- When double focusing points (□□) are selected, focusing point selection will be automatic.
- When double focusing points have been selected and a left or right focusing point is selected, only one focusing point at a time will be selected.

Focusing Point Selection



When the <FEL> button is pressed while the <MENU> is pressed, the <DISP> dial can be turned to select a focusing point toward the top or bottom.

4 The focusing point selection takes effect after 6 seconds or when the shutter button is pressed halfway.

CF

The focusing point selection method can be altered with the Custom Function CF-11. See page 116.

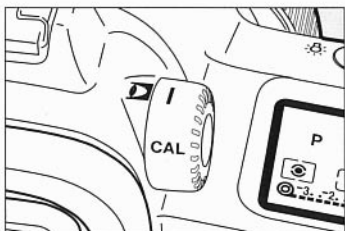

Eye-Control Focusing Point Selection

1 Set the <DISP> switch to <I>.

2 Look at the subject covered by the area AF ellipse and press the shutter button halfway.

- The selected focusing point will light and achieve focus.



CF

Custom Function CF-10 can prevent or limit the lighting up of the focusing point. See page 114.



Before you can accurately select a focusing point with Eye Control, calibration will be required. For details, see "Eye-Control Calibration" on page 42 and "Eye-Control One-Shot AF" on page 47.

About Eye-Control AF

Eye-Control AF enables you to focus at where you look within the area AF ellipse in the viewfinder. The camera instantly detects where your eye is looking and activates the corresponding focusing point (among the 45) to focus.

Eye-Control AF works in both horizontal and vertical camera orientations.

Enable Eye-Control AF by setting the **< D >** switch to **< I >**. Eye-Control AF is especially effective in the following cases:

- When you want to achieve focus instantly at the desired point.
- When you want to change the focusing point instantly.

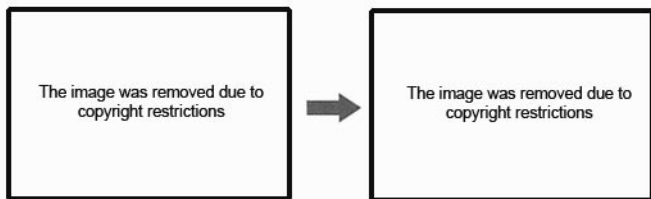

The camera automatically detects its vertical or horizontal orientation. When you switch the camera's orientation, the camera's orientation detection mechanism makes a sound. This is completely normal.

Eye-Control Calibration

Before using Eye-Control AF, you must calibrate the camera to recognize your eye movements. The camera will then be able to detect where you are looking in the viewfinder.

Calibration Procedure

You calibrate the camera by looking at a blinking focusing point in the viewfinder and then pressing the shutter button. You do this for four focusing points while holding the camera horizontally and again while holding the camera vertically. Therefore, you have to follow the calibration procedure eight times.

There are three calibration channels (CAL 1, 2, 3) which can store different calibration data.

For example, you can store calibration data in channel 1 for your naked eye and channel 2 for when you wear eyeglasses or contact lenses. Channel 3 can be used to store calibration data for another user.

- Keep your eye on the viewfinder eyepiece until you complete the calibration procedure.
- In the same calibration channel, do the calibration procedure for both the horizontal and vertical camera orientations.



If the calibration procedure is done only for the horizontal camera orientation, Eye-Control AF during vertical picture-taking may be inaccurate. You should complete the calibration procedure for both horizontal and vertical camera orientations in a calibration channel.



- 1 Set the <CAL> switch to <CAL>.
- 2 Set the <CAL> switch to <CAL>.
 - CAL and the calibration channel No. will be displayed. A blinking channel No. means that no calibration data is stored. If the channel No. does not blink, it means that calibration data has been stored in that channel.

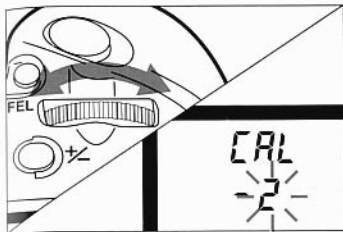

3 Turn the dial to select a blinking channel No.

- If there is no blinking channel No., see "Deleting Eye-Control Calibration Data" on page 46.

Hold the camera horizontally. The calibration sequence corresponds to the focusing points numbered from (1) to (4) in the figures.

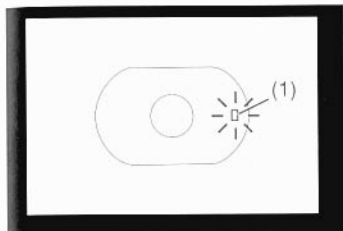

4 Keep looking at the blinking focusing point (1) in the viewfinder, then press the shutter button.

- The focusing point will stop blinking and stay lit.
- Keep looking at the lit focusing point for 1 to 2 seconds until the beeper sounds and the focusing point turns off.

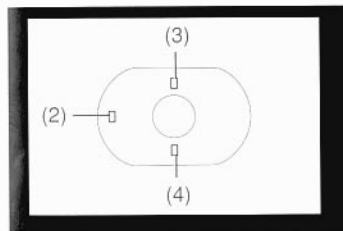

5 After you release the shutter button, the next focusing point (2) will start blinking. Repeat step 4. Repeat steps 4 and 5 for focusing points (3) and (4).



End - 2

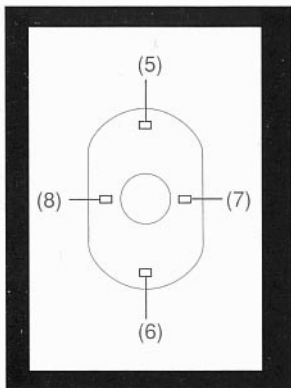

End - 2

6 After you complete the calibration procedure, the channel No. stops blinking and stays lit. "End" is also displayed.

- If you take too long during the calibration procedure and the blinking focusing point turns off, press the shutter button and start again from step 4.

After completing the horizontal calibration procedure, calibrate for the vertical camera orientation. Hold the camera vertically. The calibration sequence corresponds to the focusing points numbered from (5) to (8) in the figures.

- When the camera is held vertically with the grip upward or downward, the focusing points will still blink in the following order: top, bottom, right, left.
- For this procedure, use the same calibration channel No. you used for the horizontal calibration procedure.

7 Hold the camera vertically and press the shutter button.

- Focusing point (5) will start blinking.

8 Follow the same steps described in steps 4 to 6 for focusing points (5) to (8).

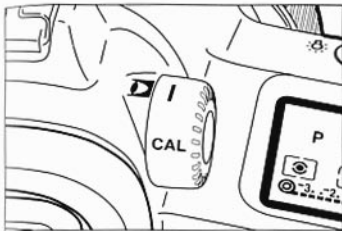

9 Set the <  > switch to < | > to end the calibration procedure.

- The viewfinder display returns to normal.



If the calibration is not completed properly, the beeper will sound and the LCD panel display items will blink. In such a case, press the shutter button again and start again from step 4.



- Calibration may not be possible if you wear mirror-type sunglasses.
- If Eye-Control AF cannot be used, use automatic or manual focusing point selection. See page 38.

Eye-Control Calibration Refinement

Eye-Control precision can be improved by repeating the calibration procedure under various conditions (outdoors, indoors, at night, etc.) for the same channel No. The additional eye-related data can accumulate in the same channel No. for both the horizontal and vertical camera orientations.

- A calibration channel must not store calibration data for more than one person. Otherwise Eye-Control precision will be affected. A different user should use a different calibration channel that is available. Or, existing calibration data should be deleted to store new calibration data. See page 46.



Calibration Tips

- Relax your shoulders and hold the camera steady in a natural posture.
- Align your line of sight with the center of the viewfinder.
- Instead of looking at the blinking focusing point itself, look at the point beyond it.
- If you wear eyeglasses, wear them properly without having them slide down your nose.





CAL is an abbreviation for calibration.

Deleting Eye-Control Calibration Data

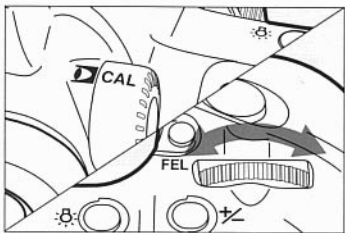
If you need to replace the calibration data in a calibration channel (for a different user, eyeglass/contact lens wear, etc.), you must first delete the existing calibration data by following the procedure below. You can then register new calibration data by following the calibration procedure.



1 Set the <  > switch to < CAL >.

2 Turn the <  > dial until the CAL No. whose calibration data is to be deleted appears (not blinking).

3 Press the <  > button and <  > button simultaneously.

- The CAL No. will start blinking. This indicates that the calibration data has been deleted.

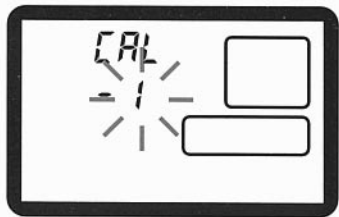
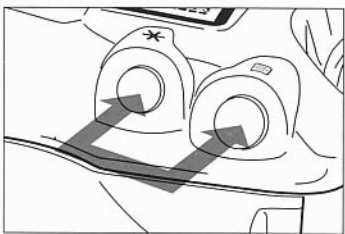

4. Eye-Control One-Shot AF Mode

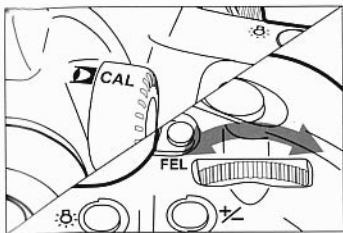

- 1 Set the <D> switch to <CAL>.
- 2 Turn the <CAL> dial to select a CAL No.

- The CAL No. lights if calibration has been completed for that channel. If calibration has not been completed, the CAL No. blinks.

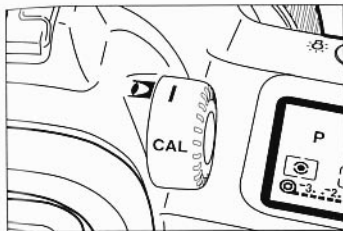

- 3 Set the <D> switch to <I>.
- 4 Select the shooting mode.
- 5 While looking at the point to be focused within the area AF ellipse, press the shutter button halfway.
 - The selected focusing point lights and achieves focus.
- 6 Take the picture.



You check the current CAL No. as follows:

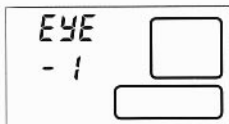

- 1 Set the <D> switch to <I>.
- 2 Press the <CAL> button.
 - *EYE* and the CAL No. will be displayed.



Eye-Control AF Selection Failure

If the focusing point cannot be eye-selected, the <D> icon in the viewfinder will blink and the camera will switch to automatic focusing point selection. See page 38.

5. Eye-Control AI Servo AF Mode

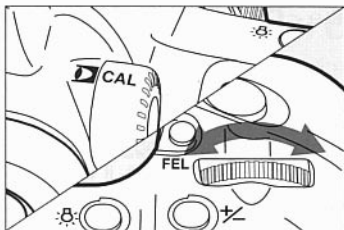

- 1 Set the <CAL> switch to <CAL>.
- 2 Turn the <FEL> dial to select a CAL No.

- If the calibration has been completed, the CAL No. will be displayed. If there is no calibration, the CAL No. will blink.

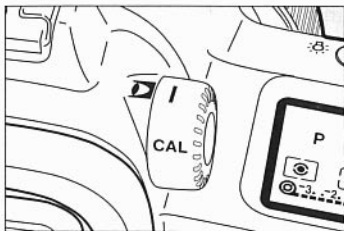

- 3 Set the <CAL> switch to <I>.
- 4 Select the shooting mode.
- 5 Look at where you want to focus within the area AF ellipse, then press the shutter button halfway.

- The corresponding focusing point, selected by eye, lights and achieves focus. This focusing point will continue to focus the subject.

- 6 Take the picture.



- The initial focusing point you select by eye remains active during continuous focusing in the AI-Servo AF mode. You cannot select another focusing point by eye during continuous focusing (while the shutter button is pressed halfway).
- If a focusing point cannot be selected by eye, the camera switches to automatic focusing point selection. See page 38.

6. Focusing an Off-Center Subject

To focus a subject not covered by the area AF ellipse, follow the procedure below. This technique is called focus lock.

- Focus lock works only in the One-Shot AF mode. See page 35.



- 1** Aim the focusing point on the subject and press the shutter button halfway to focus.



- 2** Keep pressing the shutter button halfway (this locks the focus) and recompose the picture as desired.

- 3** Press the shutter button completely to take the picture.



Evaluative metering is recommended for use with the One-Shot AF mode which locks the autoexposure setting (AE lock) at the same time focus is achieved. The exposure metering is linked to the focusing point.

● AF Sensitivity and the Lens' Maximum Aperture



The EOS-3's AF sensitivity in relation to the lens' maximum aperture is described below.

The EOS-3's focusing points are all sensitive to horizontal lines. However, depending on the maximum aperture of the lens, certain focusing points can also be sensitive to vertical lines to enhance AF precision.

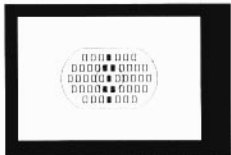

- (1) With lenses whose maximum aperture is f/2.8 or larger, the focusing points highlighted in the figure become cross sensors sensitive to both vertical and horizontal lines. The remaining 38 focusing points are horizontal-line sensitive. Cross sensors (also used as the center focusing point in the EOS-1 and EOS-1N) attain higher AF performance and precision. The sensor's vertical-line sensitivity is three times higher than horizontal-line sensitivity.

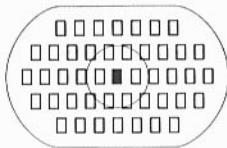

- (2) With the following lenses whose maximum aperture is f/2.8 to f/4, high-precision AF is possible with the center focusing point which works as a cross sensor. The remaining 44 focusing points are horizontal-line sensitive (except with EF 70-200mm f/2.8L USM + Extender EF 1.4x).

- EF 28-80mm f/2.8-4L USM, EF 300mm f/4L USM, EF 300mm f/4 IS USM, EF 600mm f/4L USM
- With Extender EF 1.4x:
EF 200mm f/2.8L USM, EF 300mm f/2.8L USM, EF 400mm f/2.8L USM, EF 400mm f/2.8L II USM
- With Extender EF 2x:
EF 135mm f/2L USM, EF 200mm f/1.8L USM

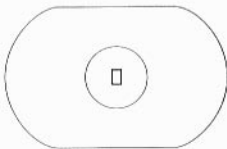

- (3) With the following lenses, if the maximum aperture is anywhere from f/5 to f/8 when an Extender is attached, the center focusing point will be sensitive to horizontal lines only. The other focusing points cannot be used for AF.

- With Extender EF 1.4x:
EF 400mm f/5.6L USM, EF 500mm f/4.5L USM
EF 100-400mm F 4.5-5.6L IS USM
- With Extender EF 2x:
EF 300mm f/4L USM, EF 300mm f/4L IS USM, EF 600mm f/4L USM
- When the  button is pressed, the display shown on the left appears on the LCD panel



7. When Autofocus Fails

Autofocus can fail to achieve focus (the in-focus indicator blinks) with certain subjects such as the following:

- (a) Low-contrast subjects.
- (b) Subjects in low light.
- (c) Extremely backlit or reflective subjects.
- (d) Overlapping near and far objects.

In such cases, do one of the following:

- (1) Focus an object at the same distance as the subject and lock the focus before recomposing.
- (2) Set the lens focus mode switch to **MF** (or **M** on older lenses) and focus manually.

- 
- You can also use the focusing aid. Select any focusing point and focus manually while pressing the shutter button halfway. When focus is achieved, the selected focusing point will light together with the in-focus indicator.
 - When the focusing point is automatically selected or eye-selected, the center focusing point flashes and the in-focus indicator lights when focus is achieved.
 - Full-time manual focus enables you to switch to manual focus anytime after the lens starts to autofocus. This feature is available in the One-Shot AF mode with USM (Ultrasonic Motor) lenses having a distance scale.

CF

For USM lenses with an electronic focusing ring (such as the EF 200mm f/1.8L), Custom Function CF-7 may require the lens focus mode switch to be set to **MF** (or **M**) before manual focus is enabled. See page 112.

- 
- If focusing cannot be achieved even while the Speedlite or ST-E2's AF-assist lamp is on, select the center focusing point to autofocus. The other focusing points might not achieve focus as readily as the center focusing point.

8. Manual Focusing

When it is difficult to autofocus, focus manually as described below.

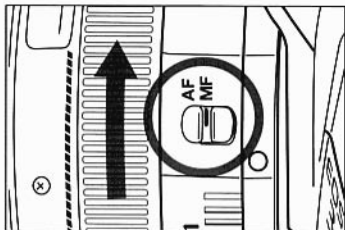

- 1** Set the lens focus mode switch to **MF** (or **M** on older lenses).
 - The AF mode indicator on the LCD panel turns off.
- 2** Turn the lens focusing ring until the subject is in focus in the viewfinder.

Metering Modes

The basic metering modes are evaluative, partial, spot, and centerweighted averaging. Spot metering can be at the center of the viewfinder or linked to the active focusing point. There is also multi-spot metering. Select the metering mode which suits the subject or your photographic intention.

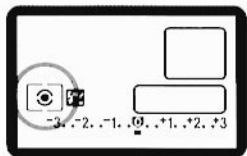

Evaluative metering



Partial metering



Spot metering





Centerweighted averaging metering

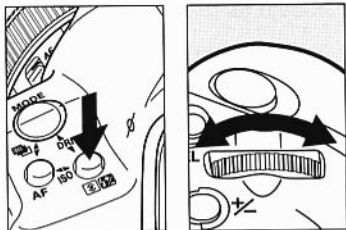

First set the <A> switch to <A>. If necessary, also set the <i> switch to <I>.

1. Selecting a Metering Mode



1 While pressing the  button, turn the  dial until the desired metering mode icon appears.

- Evaluative
- Partial
- Spot
- Centerweighted averaging

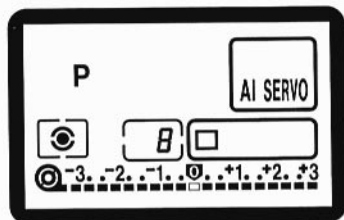

2 Release the  button.

2. Metering Modes

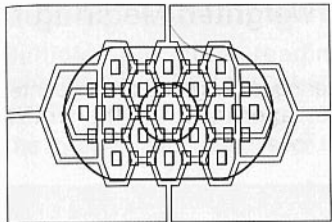

Evaluative Metering (☉)

This is an all-around metering mode suited even for backlit subjects. The viewfinder is divided into 21 metering zones. All the focusing points are linked to the evaluative metering zones. After detecting the main subject's size, position, brightness, background, front and back lighting, etc., the camera sets the proper exposure.

- In the manual focusing (**MF** or **M**) mode, evaluative metering centers on the center focusing point.
- If the subject brightness and background light level are very different (there is a strong backlight or spotlight), use partial (☉) or spot metering (☐) instead.

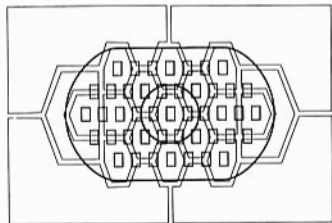

Partial Metering (☉)

This mode is effective when the background is much brighter than the subject (due to backlighting, etc.). The metering is weighted at center of the viewfinder by about 8.5%.

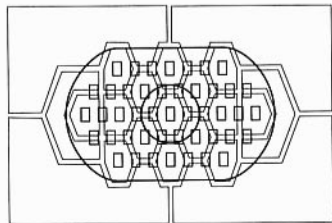

Spot Metering (☐)

This is for metering a particular part of the subject or scene. The metering is weighted at center of the viewfinder by about 2.4%.

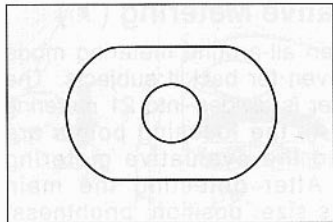

Centerweighted Metering (□)

The metering is weighted at the center and then averaged for the entire scene.

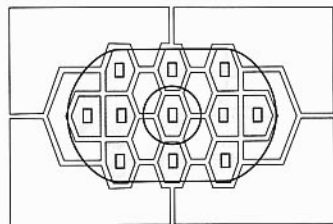

Focusing Point-Linked Spot Metering

With Custom Function CF-13, you can limit the manually- and eye-selectable focusing points to only 11 of the 45. This makes focusing point selection faster. Spot metering (about 2.4% of the viewfinder area) is also linked to the eye-selected or manually-selected focusing point.

CF

Custom Function CF-13 can limit the manually- and eye-selectable focusing points to only 11 of the 45 and keep the spot metering at the center. See page 118.



During continuous shooting, AE lock (with spot metering) is set automatically without the < * > indicator displayed in the viewfinder.

Multi-Spot Metering

Multiple spot meter readings can be taken and then averaged automatically. Up to eight spot meter readings can be taken for one picture.

The following procedure is for taking the sample photo below.

The image was removed due to copyright restrictions

- 1 Set the metering mode to spot metering. (See "Selecting a Metering Mode" on page 54.)
- 2 Aim the focusing point on a shadow portion (1) and press the <FEL> button to take a spot meter reading.

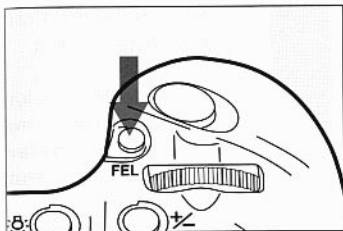

The image was removed due to copyright restrictions

- 3 Aim the focusing point on a mid-tone portion (2) and press the <FEL> button. Then aim the focusing point on a highlight portion (3) and press the <FEL> button.

Metering Modes

Each time a spot meter reading is taken, the spot meter readings taken so far are averaged and the result (shutter speed and aperture) is displayed below the viewfinder. See the figure on the next page for "Multi-Spot Metering Display." On the exposure compensation scale on the right of the viewfinder, the exposure level indicator moves around in real-time to indicate the spot meter reading's current exposure level. Each spot meter reading is also indicated on the scale with a fixed (non-moving) metering mark.

Multi-Spot Metering Display

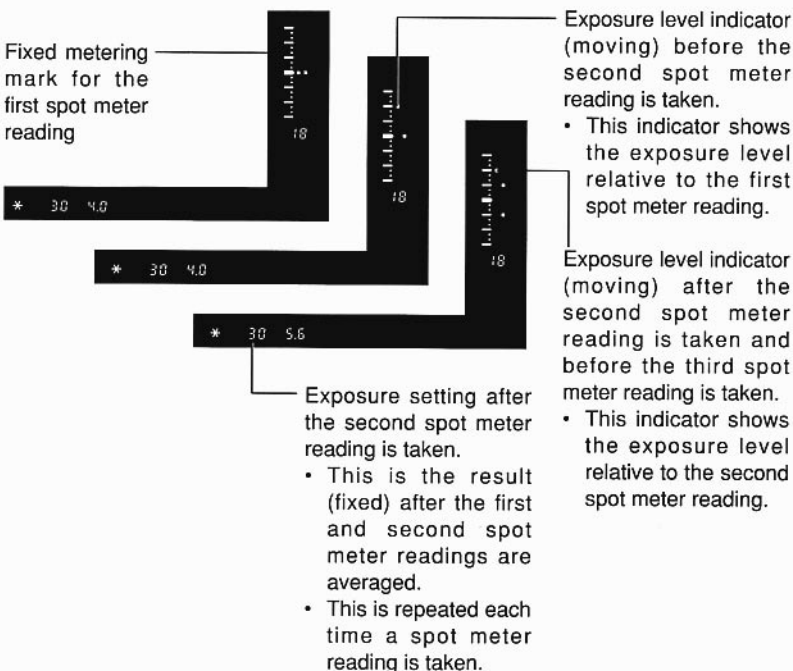

- The exposure settings obtained with multi-spot meter readings are canceled in the following cases:
 1. After a spot meter reading is taken, 16 seconds elapse.
 2. You press the , <MODE>, or <AF> button.
 3. After taking the picture, you release the shutter button.



Up to eight spot meter readings can be taken for one picture. If you press the <FEL> button to try and take a ninth spot meter reading, no spot meter reading will register.



Multi-spot metering can be fixed at the center or linked to the active focusing point.

The image was removed due to
copyright restrictions

Shooting Modes

You can set the shooting mode which best suits the subject or your photographic intention. You can also easily achieve various photographic expressions.

M : Manual (page 73)
Tv : Shutter speed-priority AE (page 62)
DEP : Depth-of-field AE (page 68)
Av : Aperture-priority AE (page 65)

bulb (page 84)

AEB (page 77)

Multiple exposures (page 82)

Exposure compensation (page 75)

: film advance (page 85)
 : self-timer (page 87)



First set the <A> switch to <A>. If necessary, also set the <0> switch to <0>.

1. Shutter Speed-Priority AE (Tv): You Set the Shutter Speed

In this mode, you set the desired shutter speed and the camera sets the aperture automatically to suit the subject brightness.

A fast shutter speed can freeze motion, and a slow shutter speed can achieve a blurred effect.



Tv is an abbreviation for Time value.

The image was removed due to
copyright restrictions

With a fast shutter speed

The image was removed due to
copyright restrictions

With a slow shutter speed

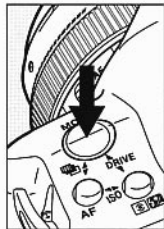

- 1 While pressing the **<MODE>** button, turn the  dial until **Tv** appears on the LCD panel.

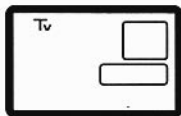

Shutter Speed-Priority AE (Tv): You Set the Shutter Speed



- 2 Release your finger from the **<MODE>** button.
- 3 Turn the  dial to set the desired shutter speed.
- 4 Press the shutter button halfway and focus the subject.
 - The shutter speed and aperture will be displayed.

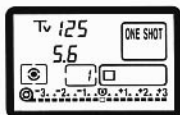

- 5 Check the aperture and take the picture.
 - As long as the aperture is not blinking, a standard exposure will be obtained.

Basic Terminology 2

● Shutter speed

The shutter speed is the length of time the camera's shutter opens to expose the film to the light coming through the lens. The shutter speed displayed on the camera's LCD panel and in the viewfinder ranges from 30 sec. to 1/8000 sec. and bulb.

Shutter Speed-Priority AE (Tv): You Set the Shutter Speed

[Exposure Warnings]

- If the lens' maximum aperture (smallest F-number like f/1.4) blinks, it indicates underexposure. Turn the  dial to set a slower shutter speed until the aperture stops blinking.



- If the lens' minimum aperture (largest F-number like f/22) blinks, it indicates overexposure. Turn the  dial to set a faster shutter speed until the aperture stops blinking.



CF

Custom Function CF-16 (see page 120) can enable the safety shift feature: If a standard exposure cannot be obtained in the shutter speed-priority AE mode with any aperture set by the camera, the camera automatically sets a faster or slower shutter speed. This feature is called safety shift.

CF

Custom Function CF-6 enables the shutter speed to be set in full-stop or half-stop increments instead of the standard 1/3-stop increments. See page 112.

2. Aperture-Priority AE (Av): You Set the Aperture

In this mode, you set the desired aperture and the camera sets the shutter speed automatically to suit the subject brightness.

The larger the aperture (smaller F-number like $f/1.4$) the more blurred the background will be. This effect is suited for portraits. The smaller the aperture (larger F-number like $f/22$), the clearer the focus will be for both near and far objects.



Av is an abbreviation for Aperture value.

The image was removed due to
copyright restrictions

With a large aperture

The image was removed due to
copyright restrictions

With a small aperture

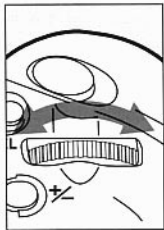
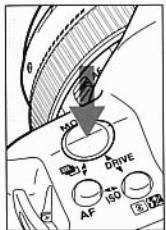

- 1 While pressing the **<MODE>** button, turn the  dial until **Av** appears on the LCD panel.





- 2 Release your finger from the **<MODE>** button.
- 3 Turn the **<gears>** dial to set the desired aperture.
- 4 Press the shutter button halfway and focus the subject.
 - The shutter speed and aperture will be displayed.

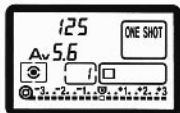

- 5 Check the shutter speed and take the picture.
 - As long as the shutter speed is not blinking, a standard exposure will be obtained.
 - If the shutter speed is less than the reciprocal of the lens focal length (i.e. 1/200 for a 200mm lens), camera shake may cause a blurred picture.

Basic Terminology 3

● Aperture

The aperture (or F-number) indicates the size of the aperture opening in the lens. The aperture displayed on the camera's LCD panel and in the viewfinder can range anywhere from 1.0 to 91, depending on the lens attached to the camera. The larger the F-number, the smaller the aperture. And the smaller the F-number, the larger the aperture.

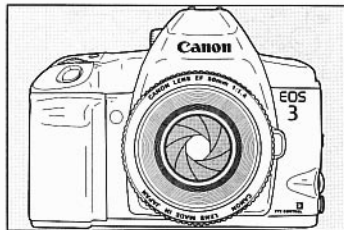

[Exposure Warnings]

- If the 30" shutter speed blinks, it indicates underexposure. Turn the dial to set a larger aperture (smaller F-number) until the shutter speed stops blinking.



- If the 8000 shutter speed blinks, it indicates overexposure. Turn the dial to set a smaller aperture (larger F-number) until the shutter speed stops blinking.



- CF** Custom Function CF-16 (see page 120) can enable the safety shift feature: If a standard exposure cannot be obtained in the aperture-priority AE mode with any shutter speed set by the camera, the camera automatically sets a larger or smaller aperture. This feature is called safety shift.
- CF** Custom Function CF-6 enables the aperture to be set in full-stop or half-stop increments instead of the standard 1/3-stop increments. See page 112.
- CF** For aperture-priority AE, Custom Function CF-5 enables the aperture to be set with the camera even while the lens is detached. See page 110.

3. Depth-of-field AE (DEP): You Set the Depth of Field

This mode is for obtaining sharp focus between a specified point in the foreground and one in the background. It is effective for large-group photos and landscapes. The optimum point of focus and aperture to attain the depth of field are set automatically along with the shutter speed. You can use this mode with a manually-selected or eye-selected focusing point.

- To use this mode, the lens focus mode switch must be set to AF.

Depth-of-field AE with a Manually-Selected Focusing Point

- 1 While pressing the **<MODE>** button, turn the **<Sun icon>** dial until **DEP** appears on the LCD panel.

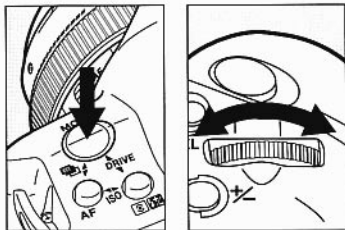

- 2 Release the **<MODE>** button.
- 3 Set the **<Df icon>** to **<O>**.
- 4 Select the focusing point.

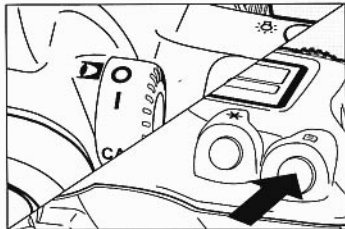

The image was removed due to copyright restrictions

- 5** Aim the selected focusing point at the nearest point or object you want in focus, then press and release the shutter button. This is DEP point 1. (⊗6)

- The in-focus indicator lights and *dEP 1* is displayed.



dEP 1 ●

- If two focusing points are active (see page 39), camera-selected focusing points will be used for setting the two *dEP* points.

The image was removed due to copyright restrictions

- 6** Use the same focusing point to aim at the farthest point or object you want in focus and press and release the shutter button. This is DEP point 2. (⊗6)

- The in-focus indicator lights and *dEP 2* is displayed.
- You can also specify DEP points 1 and 2 in reverse order.



dEP 2 ●

The image was removed due to copyright restrictions

- 7** Compose the picture and press the shutter button halfway to check that the shutter speed and aperture are not blinking. (⊗6)

The point of focus is set between the two DEP points. The aperture required to achieve the desired depth of field and a suitable shutter speed are set automatically.

- If you release the shutter button, *dEP* and the aperture will be displayed.
- The exposure setting is set immediately before the shutter is released.



125 11 ●

- 8 Press the shutter button completely to take the picture.



Depth-of-field AE with a Camera-Selected Focusing Point

- The camera selects the center focusing point for depth-of-field AE. Follow the same procedure as for "Depth-of-field AE with a Manually-Selected Focusing Point" while using the center focusing point to set the DEP points.
- Be sure to complete each step within 6 seconds (before the viewfinder display turns off) after removing your finger from the shutter button. Otherwise, the DEP settings will be canceled and you will have to start over.

Depth-of-field AE with Eye-Selected Focusing Points

With Eye Control, you can set the DEP points by looking at the focusing point. This is the easiest way.

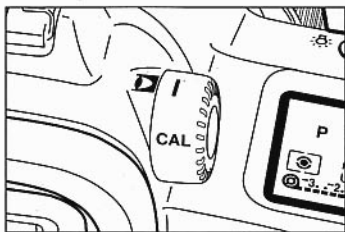

- 1 Set the <CAL> to <I>.
 - Make sure the correct CAL No. has been set. See page 42.

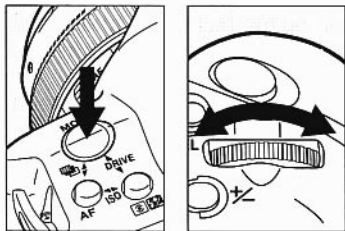

- 2 While pressing the <MODE> button, turn the <Sun icon> dial until **DEP** appears on the LCD panel.
- 3 Release the <MODE> button.

The image was removed due to
copyright restrictions

- 4** Look at the nearest point or object you want in focus, then press and release the shutter button. This is dEP point 1. (⊙6)

- The focusing point you looked at will light.
- The in-focus indicator lights and dEP 1 is displayed.



The image was removed due to
copyright restrictions

- 5** Look at the farthest point or object you want in focus and press and release the shutter button. This is dEP point 2. (⊙6)

- The focusing point you looked at will light.
- The in-focus indicator lights and dEP 2 is displayed.



The image was removed due to
copyright restrictions

- 6** Press the shutter button completely to take the picture.

- The exposure metering will be based on the focusing point you look at when you press the shutter button the third time. If you did not look at any focusing point, the exposure metering will be based on the center focusing point.



Depth-of-field AE (DEP): You Set the Depth of Field

[Exposure Warnings]

- If the aperture blinks, the desired depth of field cannot be obtained. (However, you can still take the picture and obtain a proper exposure.) Use a wide-angle lens or move away from the subject and repeat steps 4 to 6.



- If the 30" shutter speed and the lens' maximum aperture (smallest CF-number) blink, the scene is too dark and the picture cannot be taken in the depth-of-field AE mode.
- If the 8000 shutter speed and the lens' minimum aperture (largest f-number) blink, the scene is too bright. Use a neutral density (ND) filter to reduce the amount of light entering the camera.



- When using a zoom lens, do not change the zoom focal length while using the depth-of-field AE mode.
- After setting one or two dEP points, do not change the active focusing point. Doing so will cancel the dEP point(s) that has been set and you will have to start over with the newly selected focusing point.
- Depth-of-field AE cannot be used with flash. If flash is used, the result will be the same as using Program AE with flash.
- If depth-of-field AE is used with a lens having a focusing limiting switch (like the EF 300mm f/2.8 lens), set the switch to the maximum focusing distance range.



- If a slow shutter speed has been set, use a tripod to prevent camera shake.
- If six seconds elapse and the display turns off before you complete the procedure, the DEP settings entered so far will be canceled. In such a case, you must start over again.
- To cancel the depth-of-field AE mode midway, press the <MODE> button, <AF> button, or <ⓧ> button.



- To further increase the depth of field, use a wide-angle lens.
- Setting dEP points 1 and 2 at the same point on the subject will make the depth of field shallow. The foreground and background will then be blurred, making the subject stand out. Using a telephoto lens enhances this effect.

4. Manual Exposure (M): You Set the Shutter Speed and Aperture

In this mode, you set both the shutter speed and aperture for total exposure control. You can refer to the exposure level indicator in the viewfinder or use a handheld exposure meter to determine the shutter speed and aperture.

You use the <⚙> dial to set the shutter speed and the <⦿> dial to set the aperture.

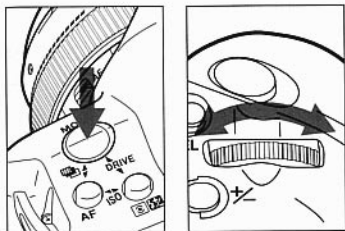

Using the Built-in Exposure Meter

- 1 While pressing the <MODE> button, turn the <⚙> dial until **M** appears on the LCD panel.



- 2 Release the <MODE> button.

- 3 Set the <⚡> switch to < I >

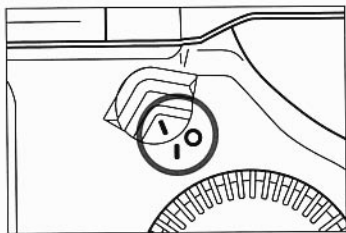

- 4 Turn the <⚙> dial to set the shutter speed and turn the <⦿> dial to set the aperture.

- You can also press the <⚡> button and turn the <⚙> dial to set the aperture.

Manual Exposure (M): You Set the Shutter Speed and Aperture

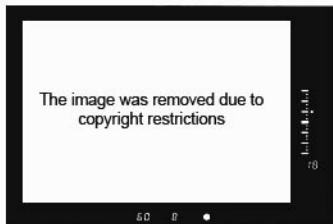

- 5 Look through the viewfinder and press the shutter button halfway. The shutter speed and aperture are displayed. On the right of the viewfinder, the exposure level indicator indicates the current exposure level relative to the standard exposure index.
- 6 While referring to the exposure level indicator, set the desired shutter speed and aperture.

CF Custom Function CF-5 can reverse the functions of the <☀> dial and <○> dial. See page 110.

CF Custom Function CF-6 can set the shutter speed and/or aperture increments to full stops or half stops instead of the standard 1/3 stops. See page 112.

CF Custom Function CF-5 enables the aperture to be set manually even when the lens has been detached. See page 110.

5. Setting Exposure Compensation

Exposure compensation is used to alter the camera's standard exposure setting. While looking through the viewfinder, you can use either the $\langle \odot \rangle$ dial or $\langle \frac{1}{2} \rangle$ button to set the exposure compensation amount. Any exposure compensation amount that you set can later be changed or canceled with the $\langle \odot \rangle$ dial or $\langle \frac{1}{2} \rangle$ button. The exposure compensation amount can be set up to ± 3 stops in $1/3$ -stop increments.

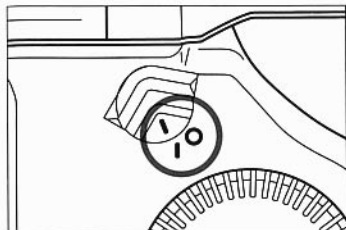

Exposure Compensation with the $\langle \odot \rangle$ Dial

- 1 Set the $\langle \odot \rangle$ switch to $\langle I \rangle$.
- 2 Focus the subject and check the exposure level.
- 3 Turn the $\langle \odot \rangle$ dial to set the desired exposure compensation amount.

- Turn the $\langle \odot \rangle$ dial while pressing the shutter button halfway or within (Ⓔ) after releasing the shutter button.
- The exposure compensation amount is indicated by the exposure level indicator ■ in the viewfinder (where the $\frac{1}{2}$ icon also lights) and the exposure compensation indicator on the LCD panel.
- On the viewfinder's exposure level scale, any position above the standard exposure index indicates overexposure and any position below it indicates underexposure. On the LCD panel, any position on the + side indicates overexposure and any position on the - side indicates underexposure.
- To cancel exposure compensation, set the amount to the standard exposure index (zero).

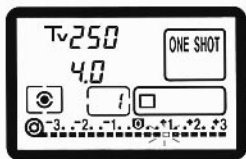

Overexposure.

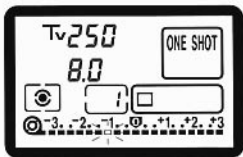

Underexposure.

- 4 Take the picture.

Setting Exposure Compensation

CF Custom Function CF-6 enables the exposure compensation amount to be set in half-stop increments. See page 112.



- The exposure compensation amount's 1/3-stop or half-stop (enabled with Custom Function CF-6) increments are indicated in the viewfinder and on the LCD panel as shown below.
- The exposure compensation amount remains effective even after the $\langle \text{Fn} \rangle$ switch is set to $\langle \text{Fn} \rangle$.

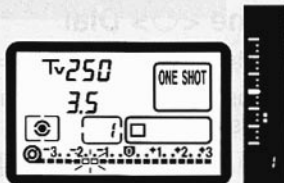

-1 1/2 exposure compensation

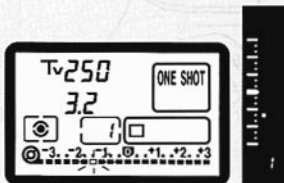

-1 1/3 exposure compensation

Exposure Compensation with the $\langle \text{Fn} \rangle$ Button

Exposure compensation can also be set with the $\langle \text{Fn} \rangle$ button and $\langle \text{Fn} \rangle$ dial.

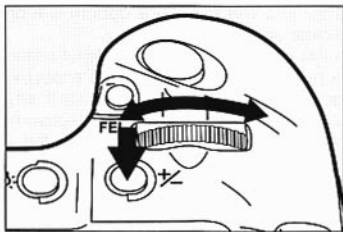

Press the $\langle \text{Fn} \rangle$ button and turn the $\langle \text{Fn} \rangle$ dial within (Fn) to set the desired exposure compensation amount.

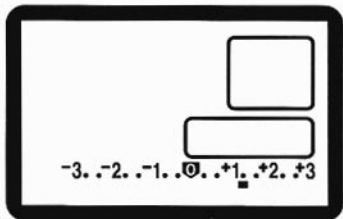

- This is useful when you want to apply the same exposure compensation to the entire roll of film.
- To prevent the $\langle \text{Fn} \rangle$ dial from turning inadvertently and changing the exposure compensation amount, set the $\langle \text{Fn} \rangle$ switch to $\langle \text{Fn} \rangle$.

6. Autoexposure Bracketing (AEB)

With autoexposure bracketing, the camera automatically changes the exposure level within the set range for three successive frames. The bracketing amount centers on the standard exposure (or exposure compensation setting), and the exposure can be varied up to ± 3 stops in $1/3$ -stop increments. The three bracketed shots are exposed in the following sequence: standard exposure, underexposure, and overexposure. The film advances in the current film advance mode (see "Switching the Film Advance Mode" on page 85).

The image was removed due to copyright restrictions

standard exposure (0)

The image was removed due to copyright restrictions

Underexposure ($-1/3$ stop)

The image was removed due to copyright restrictions

Overexposure ($+1/3$ stop)

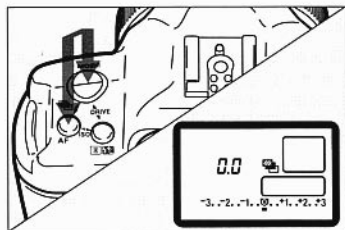

- 1 Press and hold down the **<MODE>** button and **<AF>** button simultaneously.

- The  AEB icon appears on the LCD panel.

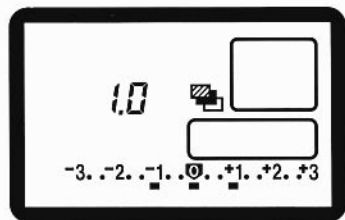

- 2 Turn the  dial to set the desired bracketing amount.

- The bracketing amount is indicated numerically and shown on the exposure compensation scale on the LCD panel.

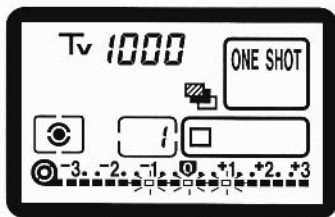

Bracketing amount set to ± 1 stop.

3 Take the pictures. The current film advance mode will be used.

- On the viewfinder's exposure level scale, the exposure level indicator will mark the respective bracketing amount as each bracketed shot is taken.
- In the continuous shooting mode, holding down the shutter button will take all three bracketed shots continuously. The shooting will then stop automatically.
- When AEB is used with the self-timer, the three bracketed shots will be taken in succession after the 2- or 10-second self-timer delay.



To indicate that AEB is in progress, the  AEB icon on the LCD panel and \star indicator in the viewfinder will blink until all the bracketed shots are taken.

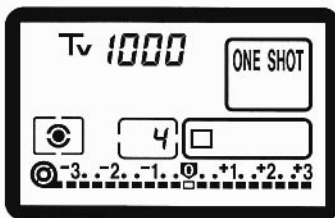

Canceling AEB

Follow steps 1 and 2 to set the AEB to 0.

- AEB will also be canceled by changing lenses, rewinding the film, replacing the film, setting a bulb exposure, having a flash-ready Speedlite, pressing the <CLEAR> button, and setting the $\langle \text{AEB} \rangle$ switch to $\langle \text{OFF} \rangle$.

CF

Custom Function CF-6 enables the AEB amount to be set in half-stop increments. See page 112.

Custom Function CF-9 can change the bracketing sequence to underexposure, standard exposure, and overexposure. See page 114.

Custom Function CF-9 can prevent AEB from being canceled by changing lenses, rewinding the film, replacing the film, and setting the $\langle \text{AEB} \rangle$ switch to $\langle \text{LOCK} \rangle$. See page 114.



- No viewfinder information will be displayed during continuous shooting of the bracketed shots.
- After the AEB amount is set, exposure compensation can also be set to obtain underexposed or overexposed bracketing. See "Setting Exposure Compensation" on page 75.
- AEB cannot be used together with bulb exposures or flash.
- If mirror lockup is set with Custom Function CF-12 and AEB is used, single-frame shooting will take effect even if the film advance mode is set to continuous shooting.

7. AE Lock

Normally, the camera's autoexposure meter reading changes in real-time when you change the camera angle. AE lock prevents the meter reading from changing even when you recompose the shot. This feature is useful for backlit and spotlighted subjects.

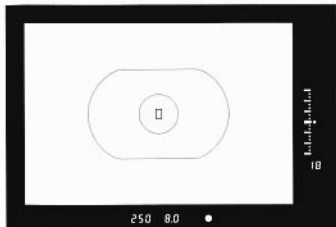

1 Focus at the point where you want to lock the meter reading.

- The exposure setting (shutter speed and aperture) will be displayed on the LCD panel and in the viewfinder.

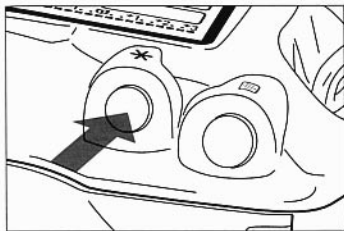

2 Press the **< * >** button. (06)

- **< * >** lights in the viewfinder to indicate that the exposure setting is locked.
- Each time you press the **< * >** button, it locks the current exposure setting.
- AE lock cancels 6 seconds after you press the **< * >** button or if you press the **< AF >** button, **< [] >** button, or **< MODE >** button.

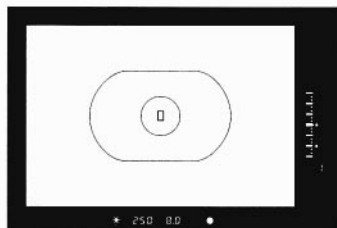

AE lock indicator

3 Focus at the desired point, recompose the shot, and take the picture.

- When the shot is recomposed, the exposure level indicator will show the new exposure level in real-time relative to the locked exposure level.

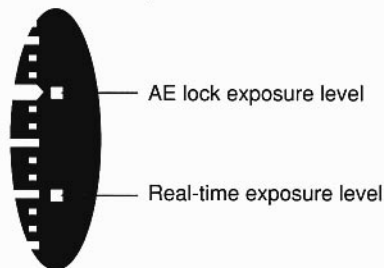

AE lock exposure level

Real-time exposure level

CF Custom Function CF-4-1 enables AE lock with the shutter button (instead of the < * > button) pressed halfway and focusing with the < * > button. See page 108.



Partial or spot metering is recommended for AE lock over a specific point. See page 54.



If One-Shot AF and evaluative metering are set, pressing the shutter button halfway to focus will automatically set AE lock at the same time.

8. Setting the Film Speed Manually

If the film is not DX-coded or if you want to set a different ISO film speed, load the film and set the ISO film speed manually.

- The ISO film speed can be set manually from 6 to 6400.

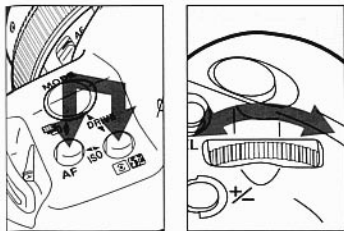

1 Press and hold down the **<AF>** button and **<ISO>** button simultaneously.

- The **<ISO>** icon and the currently-set film speed will be displayed.

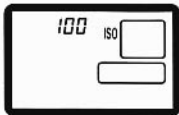

2 Turn the **<ISO>** dial until the desired film speed is displayed on the LCD panel.

3 Release the two buttons. The film speed will then be set.

 The manually-set film speed will be canceled the next time DX-coded film loaded.

9. Multiple Exposures

By not advancing the film, a single frame can be exposed multiple times. Up to nine multiple exposures can be set for one frame. Multiple exposures can be taken in any shooting mode.

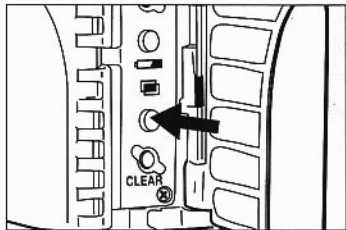

1 Open the side door and press the button.

- The  icon appears on the LCD panel and the frame counter displays "1." This number indicates the number of multiple exposures.

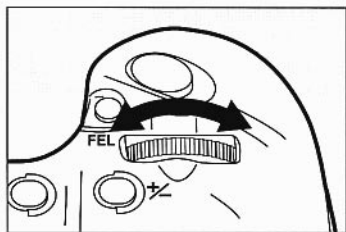
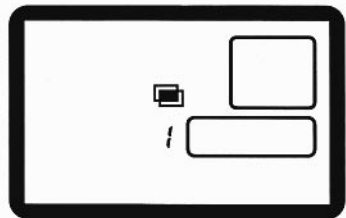

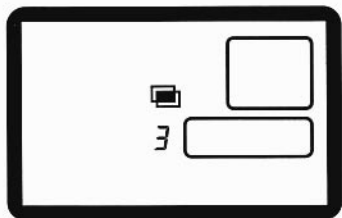

2 Turn the dial to set the desired number of multiple exposures.



Set for 3 multiple exposures.

- 3 The setting takes effect after ( 6) or when you press the shutter button halfway.
- 4 Set the shooting mode and press the shutter button completely for each multiple exposure.
- 5 After all the multiple exposures are taken, the film advances to the next frame automatically and the multiple exposure setting is canceled.

 If any of the film's first or last frames is used for multiple exposures, the exposures may not align exactly due to film advance characteristics.

-  • While multiple exposures are being taken, the multiple exposure icon  blinks on the LCD panel.
- To cancel the multiple exposure setting before taking multiple exposures, set the number of multiple exposures to 1.
- To cancel the multiple exposure setting after you start taking multiple exposures, follow steps 1 and 2 and set the number of multiple exposures blank.

 When taking multiple exposures, you should underexpose each multiple exposure by the amounts shown below. To underexpose, see "Setting Exposure Compensation" on page 75.

Exposure Compensation Guide for Multiple Exposures

No. of Multiple Exposures	2	3	4
Underexposure Amount of Each Exposure	-1.0 stop	-1.5 stop	-2.0 stops

- These exposure compensation amounts are only general guidelines. The optimum amount depends on the scene. Experiment to find the optimum compensation amount.

10. buLb Exposures

When bulb is set, the film is exposed during the time you keep pressing the shutter button completely. Bulb is useful when a long exposure is necessary for capturing night scenes, fireworks, and the night sky.

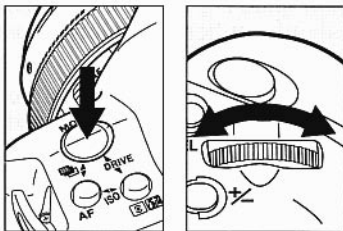

- 1 While pressing the <MODE> button, turn the <MODE> dial until *buLb* is displayed.

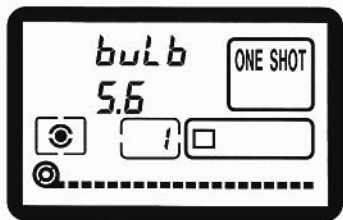
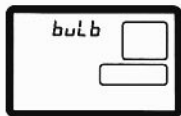

- 2 Release the <MODE> button.
- 3 Set the <MODE> switch to <I>.
- 4 Turn the <MODE> dial to set the desired aperture.
- 5 Press and hold down the shutter button completely for the duration of the exposure.



- When the bulb exposure starts, the frame counter on the LCD panel counts the elapsed exposure time from 1 to 30 seconds. After every 30 seconds, one segment (---) on the exposure compensation scale appears and the frame counter resets to 1. Therefore, if three segments are displayed and the frame counter reads "30," it means 120 seconds have elapsed.
- Bulb exposures consume almost no battery power.
- To connect a remote controller (Remote Switch 60T3, etc.) to the camera, use Remote Switch Adapter RA-N3.



Connecting Remote Switch RS-80N3 (shutter release lock provided) or Timer Remote Controller TC-80N3 (both sold separately) to the camera's remote control terminal relieves your finger from pressing the shutter button during bulb exposures.

11. Switching the Film Advance Mode

The film advance mode can be set to single-frame shooting or continuous shooting.

Single-frame Shooting (□)

After a picture is taken, the film advances by one frame automatically.

Continuous Shooting (📷)

The film advances at a rate of 4.3 frames per second while you hold down the shutter button completely.

- The rate of 4.3 frames per second applies when the shutter speed is 1/250 sec. or faster.
- With One-Shot AF and evaluative metering set, if you stop continuous shooting by returning the shutter button to the halfway position, you can maintain the AE lock for the next time you start shooting.

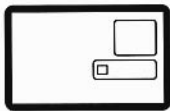
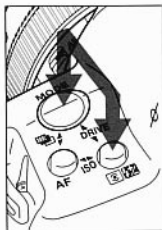

1 Press and hold down the <MODE> button and <📷> button simultaneously.



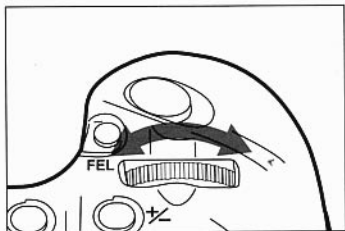

- The current film advance mode is displayed.



2 Turn the <📷> dial to set the desired film advance mode.

3 Release the two buttons.









When , , L, or H Blinks

If the battery power drops in cold temperatures or the film advance operation is slow, it means that the camera is trying to provide film advance power rather than speed. This feature is called automatic film advance transmission. If this is activated, one of the film advance icons (, , L, H) will blink on the LCD panel. This feature is canceled when you press the <MODE> button or <Ⓢ> button or when you replace the film or battery. If this feature is activated, check the battery power (see page 22) and follow the respective countermeasures.

- If film advance or rewind stops midway,  will blink on the LCD panel. When the battery is replaced with a new one, film advance will resume. To resume film rewind, press the midroll rewind button.
- In cold temperatures, warm the battery in your pocket, etc., to enable use.

Continuous Shooting Rates

(approx. frames/sec.)

Configuration	Power Source	Film Advance Mode	One-Shot AF / Manual Focus	AI Servo AF
EOS 3	2CR5 lithium battery		4.3	3.3
EOS 3 + BP-E1	Size-AA alkaline batteries × 4			
EOS 3 + PB-E2	Nickel Hydride Pack NP-E2		7	7
		 L	3	3
	Size-AA alkaline batteries × 8		6	5
		 L	3	3
EOS-3 + Power Drive Booster E1	Size-AA alkaline batteries × 8		6	5
		 L	3	3



No viewfinder information is displayed during continuous shooting.

12. Self-timer Operation

The self-timer can be set to either a 2-second or 10-second delay. When using the self-timer, you should mount the camera on a tripod.

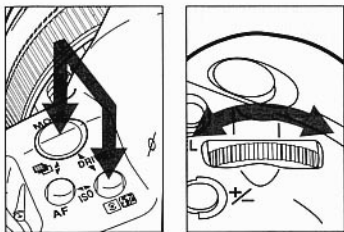

- 1 While pressing the **<MODE>** button and **<☑>** button, turn the **<☀>** dial and set the desired self-timer delay time.



☀¹⁰ : 10-second delay

☀₂ : 2-second delay



The 2-second delay is effective for close-ups or photo duplicating work to prevent camera shake (camera movement while the shutter button is pressed).

- 2 Look through the viewfinder and press the shutter button halfway. Make sure the in-focus indicator and exposure setting are displayed.

- 3 Press the shutter button completely. The self-timer lamp will start blinking to indicate that the self-timer has started. The lamp blinks faster during the two seconds before the picture is taken.

- To cancel the self-timer after it starts, set the **<☑>** switch to **<☒>**.

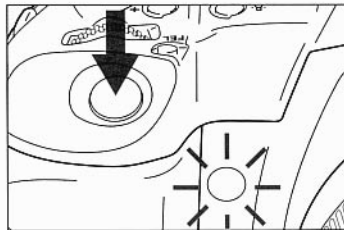

Do not stand in front of the camera when you press the shutter button to start the self-timer. Doing so will throw off the focus.

Attaching the Eyepiece Cover

If you take a picture without looking through the viewfinder, stray light may enter the eyepiece and affect the exposure. To prevent this, detach the eyecup and attach the eyepiece cover (provided on the strap) on the eyepiece before taking the picture.

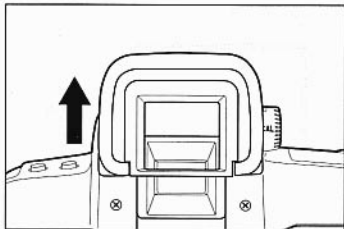

- 1** Remove the eyecup.

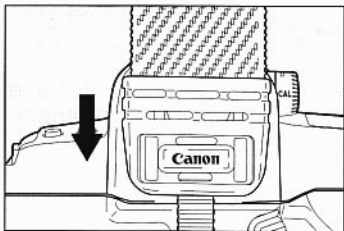

- 2** Slip on the eyepiece cover over the eyepiece.

13. Mirror Lockup

Mirror lockup is enabled with Custom Function CF-12 (see page 116). This prevents mirror-caused vibrations which may blur the image during close-ups or when a super telephoto lens is used. To set this Custom Function, see "Setting and Canceling Custom Functions" on page 104. When mirror lockup is set, the camera operates as follows:

- When using mirror lockup, Remote Switch RS-80N3 (sold separately) is recommended.

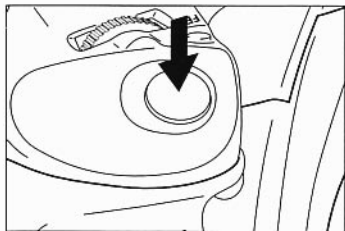

1 Press the shutter button completely. The mirror locks up.

- After 30 seconds, the mirror goes back down automatically. Pressing the shutter button completely again locks up the mirror again.

2 Release the shutter button and press the shutter button completely again to take the picture. The mirror then goes back down after the picture is taken.



- In very bright light such as at the beach or ski ground on a sunny day, take the picture promptly after mirror lockup.
- During mirror lockup, do not point the camera lens at the sun. The sun's heat can scorch and damage the shutter curtains.
- If you use mirror lockup with the self-timer for a bulb exposure, there will be a shutter release sound when you release the shutter button during self-timer operation. This is not the sound of the shutter release.



- During mirror lockup, the film advance mode will be single-frame shooting regardless of the current film advance mode.
- If mirror lockup is used with the self-timer, pressing the shutter button completely the first time will lock up the mirror and release the shutter 10 seconds or 2 seconds later (depending on the delay time selected).

14. Depth-of-field Preview

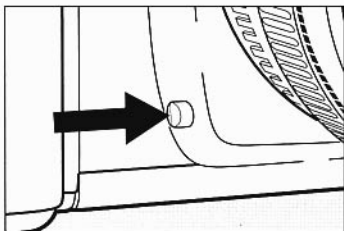

The depth of field is the range of acceptable focus in front of and behind the point of focus. The depth of field changes depending on the aperture. Press the depth-of-field preview button to stop down the aperture and preview this range of acceptable focus.



- Pressing the depth-of-field preview button also sets AE lock.
- The depth-of-field preview button does not function during AF operation.

15. LCD Panel Illumination

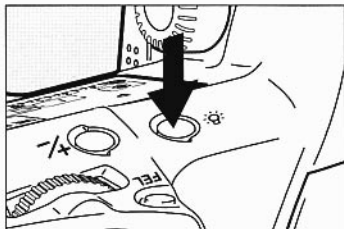

The LCD panel can be illuminated. The LCD panel illumination button turns the illumination on (for 6 sec.) and off. The LCD panel illumination turns off 2 seconds after a picture is taken.



- Pressing any button while the LCD panel is illuminated prolongs the illumination.
- The illumination turns off at the start of a bulb exposure.

Flash Photography

An EOS-dedicated EX-series or EZ-series Speedlite makes flash photography with the EOS-3 as easy as any AE mode. With an EX-series Speedlite, E-TTL autoflash photography as well as wireless E-TTL multi-flash photography is possible.

Speedlite 550EX will be used to describe the flash photography features provided with the EOS-3. For details on Speedlite 550EX, see the Instructions that come with it.

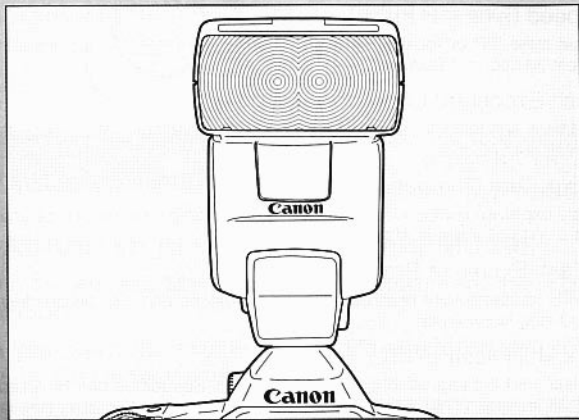

First set the switch to A. If necessary, also set the switch to I.

1. Flash Photography with Speedlite 550EX

With Speedlite 550EX attached to the EOS-3, flash photography is as easy as an AE mode. You can also use the following features:

(1) E-TTL Autoflash

With E-TTL autoflash (preflash evaluative metering), optimum flash exposure can be obtained for the subject in focus. In the aperture-priority AE mode, a slow sync speed is set automatically in low-light situations to obtain a natural-looking, balanced exposure between the subject and background.

The image was removed due to copyright restrictions

(2) High-Speed Sync (FP Flash)

High-speed sync (FP or focal-plane flash) enables flash synchronization with all shutter speeds from 30 sec. to 1/8000 sec.

(3) FE (Flash Exposure) Lock

FE lock obtains and locks the correct flash exposure for any part of the subject. This is the flash equivalent of AE lock.

(4) Flash Exposure Compensation

Like normal exposure compensation, flash exposure compensation can be used to set the flash output up to ± 3 stops in 1/3-stop increments.

(5) FEB (Flash Exposure Bracketing)

As with AEB (autoexposure bracketing), flash exposures can also be bracketed up to ± 3 stops in 1/3-stop increments.

(6) Wireless Multi-flash E-TTL

For sophisticated lighting effects, multiple wireless Speedlites can be used for E-TTL autoflash. All features (1) to (5) above can be used. The operation is as simple as using a Speedlite directly attached to the camera.



E-TTL is an abbreviation for Evaluative-Through-The-Lens.

- With autofocus, the flash exposure is always based on the aperture (set automatically or manually) and autoflash metering is weighted at the current focusing point.
- When it is difficult to autofocus, the 550EX's built-in AF-assist beam is emitted automatically. The beam is linked to the area AF.

Full Auto Flash

Full Auto E-TTL autoflash used with the Program AE mode is described here. For details on Speedlite 550EX operations, see the Instructions that came with it.

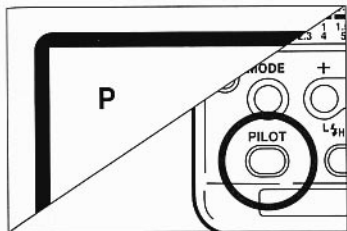

- 1 Set the camera's shooting mode to **P**.
- 2 Check that the 550EX's pilot lamp is lit.
- 3 Focus the subject.



- 4 Make sure the flash-ready indicator  is lit, check the shutter speed and aperture, then take the picture.

E-TTL Autoflash in Other Shooting Modes



Even in the **Tv**, **Av**, and **M** modes, E-TTL autoflash can be used as easily as without flash.

- (1) When you press the shutter button, the shutter speed and aperture are set by the camera as usual.

Mode	Shutter Speed Setting	Flash Aperture Setting
Tv (Shutter speed-priority AE)	Manual (30 sec. - 1/200 sec.)	Auto
Av (Aperture-priority AE)	Auto (30 sec. - 1/200 sec.)	Manual
M (Manual)	Manual (30 sec. - 1/200 sec.)	Manual

- (2) When you press the shutter button completely, preflash evaluative metering based on the aperture setting is used for the flash exposure.
- (3) The background exposure is set by the shutter speed and aperture combination.

High-Speed Sync (FP Flash)

When the Speedlite's high-speed sync lamp () is on, high-speed sync (FP or focal-plane flash) is enabled automatically. The Speedlite can then synchronize at all shutter speeds, even those faster than 1/200 sec. When high-speed sync is enabled,  is displayed in the viewfinder to indicate high-speed sync.

High-speed sync is effective in the following cases:

- (1) When you want to use fill-in flash for a portrait and maintain background blur with a large aperture.
- (2) When you want to produce a catchlight in the subject's eyes.
- (3) When you want to use fill-in flash to eliminate shadows



The image was removed due to
copyright restrictions

With conventional flash.

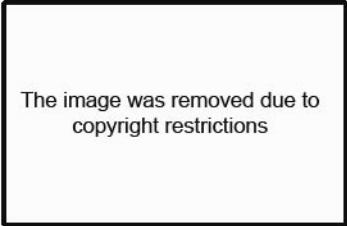

The image was removed due to
copyright restrictions

With FP flash.

FE Lock

FE (flash exposure) lock obtains and locks the correct flash exposure reading for the desired portion of the scene.

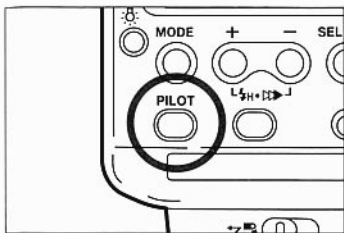

1 Check that the Speedlite's pilot lamp is lit.

- The flash mode can be either normal or high-speed sync. FE lock works with either mode.

2 Focus the subject with AF or manual focus.

3 Aim the spot metering circle over the part where you want to lock the flash exposure, then press the <FEL> button. (16 sec.)

- The Speedlite fires a preflash and calculates the required flash output which is then stored in memory.
- In the viewfinder, the focusing point linked to the FE lock flashes in red.

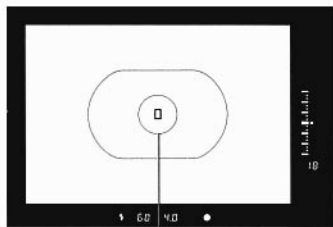

Spot metering circle

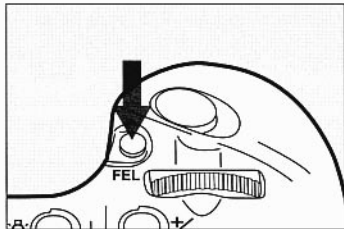

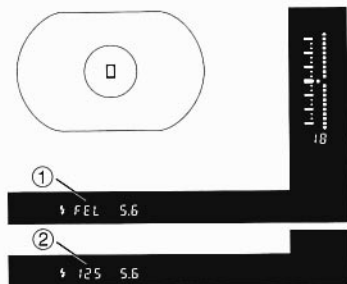

- Below the viewfinder, the display shown in ① appears for 0.5 sec. followed by the display shown in ②.



4 Compose the shot and take the picture.

For this picture, FE lock was used to lock the flash exposure reading for the face and then the shot was recomposed. The subject was exposed properly without being affected by the background reflection.



- If the subject is too far away resulting in underexposure, the lightning bolt icon will blink. Get closer to the subject and follow steps 3 and 4.
- When shooting more than one exposure of the same subject, FEL must be set again for each shot.



Custom Function CF-13 enables FE lock with the manually-selected or eye-selected focusing point. See page 118.

Flash Exposure Compensation

When an EOS-dedicated Speedlite is used, you can set flash exposure compensation with the camera up to ± 3 stops in 1/3-stop increments.

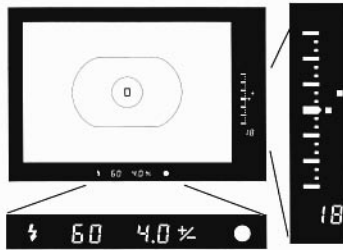
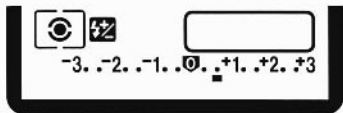
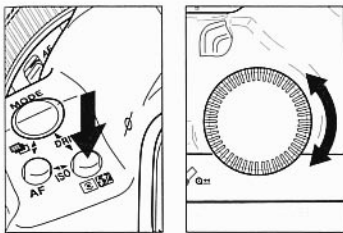

- 1 While pressing the $\langle \text{□} \pm \rangle$ button, turn the $\langle \text{○} \rangle$ dial to set the desired flash exposure compensation amount.

- On the LCD panel, the plus side of the scale indicates overexposure and the minus side indicates underexposure. The sample LCD panel on the left shows a flash exposure compensation amount of +2/3 stop.

- 2 Release the $\langle \text{□} \pm \rangle$ button and the normal display returns.

- Press the shutter button halfway to display the flash exposure compensation amount on the viewfinder's exposure level scale.
- Press the $\langle \text{□} \pm \rangle$ button to display the flash exposure compensation amount on the LCD panel.
- To cancel flash exposure compensation, set the flash exposure compensation amount to $\langle \text{0} \rangle$.



Custom Function CF-6 enables the flash exposure compensation amount to be set in half-stop increments. See page 112.



- The flash exposure compensation amount is retained even when the $\langle \text{□} \rangle$ switch is set to $\langle \text{L} \rangle$.
- Flash exposure compensation can be set with Canon Speedlites 550EX, 540EZ, and 430EZ. If flash exposure compensation is set with both the Speedlite and camera, the flash exposure compensation amount set with the Speedlite overrides the amount set with the camera.

FEB (Flash Exposure Bracketing)

Three successive flash shots can be bracketed automatically according to the bracketing amount set with Canon Speedlite 550EX. Without changing the background exposure, you can bracket the flash exposure for the subject up to ± 3 stops in 1/3-stop increments.

The images were removed due to copyright restrictions

Correct exposure.

Underexposure ($-1/3$ stop).

Overexposure ($+1/3$ stop).

- Flash exposure bracketing is set with the 550EX. For details, see the 550EX's Instructions.
- The flash exposure bracketing amount set with the 550EX can be displayed in the camera's viewfinder.
- Before taking FEB pictures, be sure the Speedlite 550EX is ready. Single-frame shooting is recommended.



The flash exposure bracketing amount can also be set in half-stop increments. See page 112.

Modeling Flash

By using modeling flash, you can see the shadows and other flash lighting effects produced by the flash or multiple flash units.

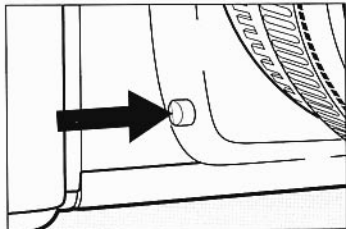

- 1 Check the Speedlite and camera settings.
- 2 Press the camera's depth-of-field preview button.
 - The Canon Speedlite 550EX fires at 70 Hz for 1 second.

Wireless Multi-Flash System

The Canon Speedlite 550EX has the following three features:

- (1) E-TTL autoflash
- (2) Slave unit
- (3) Wireless master control of other slave-triggered 550EX units

By using the above features, you can set up a wireless E-TTL autoflash system with up to three Speedlites. You can also set the flash output ratio between the Speedlites to create the desired flash lighting effect.

- For details, see the 550EX and ST-E2's Instructions.

Wireless multi-flash system

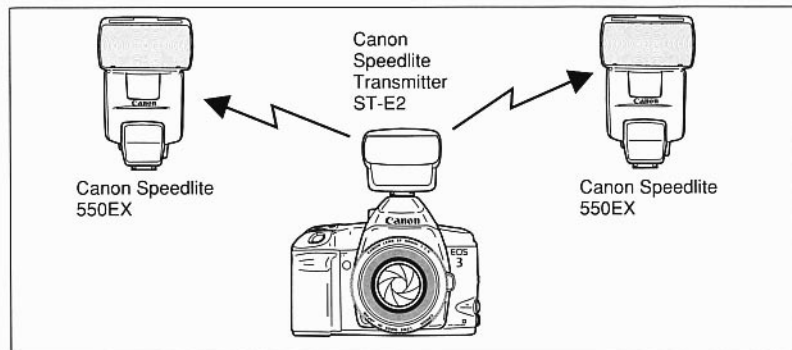

2. Using Other EOS-Dedicated Speedlites

With an EOS-dedicated Speedlite other than the EX series, TTL autoflash can be used as easily as normal AE modes. The flash exposure is controlled by off-the-film flash metering linked to the focusing point.

- (1) When you press the shutter button halfway, the shutter speed and aperture are set automatically by the camera.

Mode	Shutter Speed Setting	Flash Aperture Setting
P (Program AE)	Auto (1/60 sec. - 1/200 sec.)	Auto
Tv (Shutter speed-priority AE)	Manual (30 sec. - 1/200 sec.)	Auto
Av (Aperture-priority AE)	Auto (30 sec. - 1/200 sec.)	Manual
M (Manual)	Manual (30 sec. - 1/200 sec.)	Manual

- (2) When you press the shutter button completely, TTL autoflash metering based on the aperture setting is used for the flash exposure.
- (3) The background exposure is set by the shutter speed and aperture combination.



- Flash exposure compensation can be set with the camera.
- If the multi-flash system is wired with flash cords, TTL autoflash takes effect.
- Cover the main subject with the area AF ellipse.
- Automatic Reduction of Flash Output

If an EOS-dedicated Speedlite is used for a subject backlit by a top light, the flash output is reduced automatically to avoid having an unnatural-looking exposure. This is called automatic reduction of flash output.



Custom Function CF-14 can prevent the automatic reduction of flash output. See page 118.

3. Using Non-Canon Flash Units

Sync Speed

The EOS-3 can synchronize with compact, non-Canon flash units at 1/200 sec. or slower shutter speeds. With large studio flash, the sync speed is 1/125 sec. or slower. Be sure to test the flash to see if it synchronizes properly with the camera.

PC Terminal

The camera's PC terminal is provided for flash units using a sync cord. The PC terminal is threaded to prevent inadvertent disconnection. Only X-sync is used for synchronization at 1/200 sec. or slower.



A flash unit attached to the camera's hot shoe and a flash unit connected to the PC terminal can be used at the same time.

- Canon EOS-dedicated Speedlites are recommended for use with this camera.



If the camera is used with a flash unit or flash accessory dedicated to another camera brand, the camera may not operate properly and camera malfunction may result.

- There are studio flash units whose sync cord polarity is opposite from the camera's PC terminal. Such flash units do not work with the camera. Consult the manufacturer of the flash unit or purchase a commercially-available polarity conversion cord. The camera's PC terminal polarity is shown in the figure on the right.

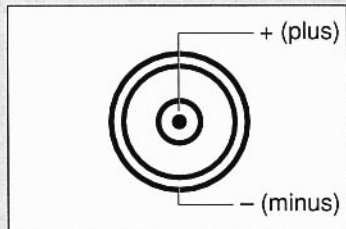

Basic Terminology 4

● Depth of Field

This is the range in front of and behind the plane of optimum focus where acceptable focus can be achieved. The smaller the aperture (the larger the F-number), the greater the depth of field will be. And the larger the aperture (the smaller the F-number), the shallower the depth of field will be.

The depth of field is affected as described below:

- (1) A smaller aperture (a larger F-number) increases the depth of field.
- (2) A lens with a shorter focal length increases the depth of field.
... A wide-angle lens obtains a greater depth of field than a telephoto lens.
- (3) A longer distance between the camera and subject increases the depth of field.
- (4) The depth of field behind the plane of optimum focus is twice as long as the depth of field in front of the plane of optimum focus.

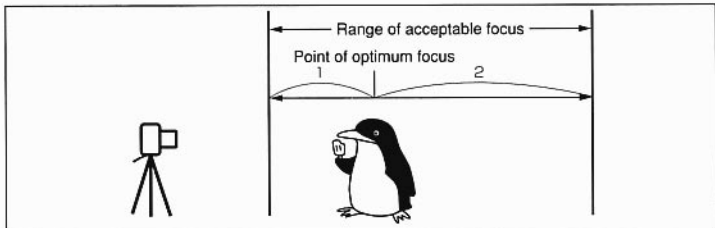

The images were removed due to
copyright restrictions

Taken with an $f/22$ aperture.



Taken with an $f/2$ aperture.

Custom Functions

You can customize camera functions with the camera's Custom Functions.

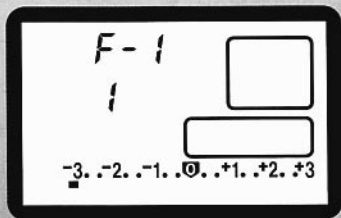
In the previous text, the CF symbol was used to point out a relevant Custom Function. In this chapter, all the Custom Functions are described in detail.



First set the  switch to **<A>**. If necessary, also set the  switch to **<1>**.

1. Setting and Canceling Custom Functions

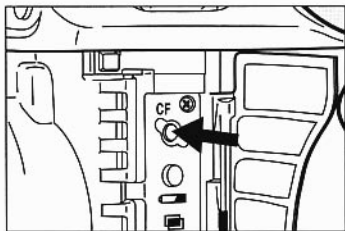

Setting a Custom Function

1 Open the side door and press the <CF> button.

- The Custom Function No. appears on the LCD panel.

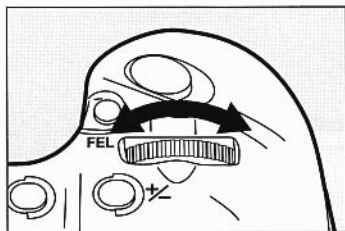

2 Turn the <FEL> dial until the desired Custom Function No. appears.

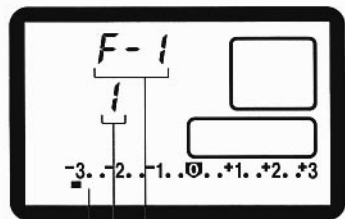

3 Then press the <CF> button to change the Custom Function's setting. Each time you press the <CF> button, the Custom Function setting changes.

- To change Custom Function *F-0*'s setting, press the <CF> button for at least 2 seconds. See page 133.

4 Press the shutter button halfway. The LCD panel returns to the normal display and the new Custom Function setting takes effect.

- While you use the camera, you can check the Custom Function setting by pressing the <CF> button.

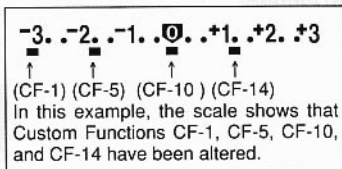

Altered Custom Function Indicator

The Custom Functions which you have altered are indicated on the exposure compensation scale.

The scale's increments from left to right are used to mark the 17 Custom Functions. The left-most increment (-3) is for Custom Function CF-1. The next increment to the right denotes the next Custom Function in numerical order up to CF-17.

Canceling a Custom Function

- 1 Select the Custom Function No. whose setting is to be canceled, then press the **<CF>** button until the setting returns to  on the LCD panel.
- 2 Press the shutter button halfway. The LCD panel returns to the normal display.

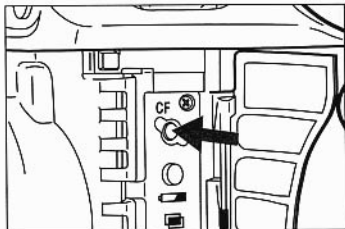

Canceling All Custom Functions

To reset all Custom Functions (except CF-0) to 0, open the side door and press the CF button. Then press the **<CLEAR>** button.

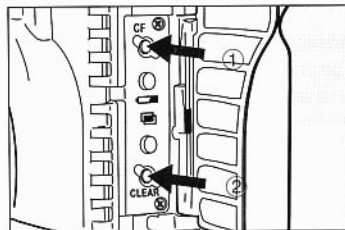



2. Custom Function Settings

Custom Function CF-0 makes the camera's built-in exposure meter compatible with the focusing screen. Be sure to set this Custom Function to suit the focusing screen installed in the camera.

Custom Functions CF-1 to CF-17 can be set to suit your preferences.

Custom Function	No.	Setting
Match the focusing screen	CF-0	0
		1











Custom Function	No.	Setting	Description
Film rewind mode	CF-1	0	High-speed automatic film rewind.
		1	No automatic film rewind. → Pressing midroll rewind <  > button executes high-speed rewind.
		2	Silent automatic film rewind.
		3	No automatic film rewind. → Pressing midroll rewind <  > button executes silent rewind.

Focusing Screen	Page
Setting for focusing screen Ec-N or Ec-R (N : New Lasermatte Screen). Setting for focusing screens Ec-A, Ec-B, Ec-C, Ec-CII, Ec-D, Ec-H, Ec-I, Ec-L (L : Lasermatte Screen)	133

Remarks	Page
Settings 1 and 3 are ideal when film rewind noise would be disturbing.	28

Custom Function	No.	Setting	Description
Film leader position after film rewind	CF-2	0	Rewinds the film leader into the cartridge.
		1	Leaves the film leader outside the cartridge.
ISO film speed setting method	CF-3	0	Sets the film speed automatically with DX-coded film.
		1	Enables the film speed to be set manually.
AF activation method	CF-4	0	Enables AF and AE operation by pressing the shutter button halfway. <ul style="list-style-type: none"> • AE lock with the < * > button.
		1	Enables AE and AF operations with the < * > button. <ul style="list-style-type: none"> • Shutter button pressed halfway enables AE lock.
		2	Shutter button pressed halfway enables AF and AE operation. <ul style="list-style-type: none"> • AF lock (no AE lock) with the < * > button.
		3	Enables AF and AE operation (no AE lock) with the < * > button. <ul style="list-style-type: none"> • Pressing the shutter button completely releases the shutter (pressing it halfway executes AE operation only).

Remarks	Page
<p>This is convenient if you develop the film yourself.</p> <ul style="list-style-type: none">• If 1 is set, the shutter speed will always be 1/8000 sec. if you release the shutter with the camera back open.	28
<p>This is effective if you want to set the film speed yourself. You can be relieved from setting the film speed each time you load film.</p>	26 27 81
<p>This is effective when you want to focus and meter at different portions of the scene.</p> <p>This is effective when you want to stop AI Servo AF operation momentarily. If an obstruction comes between the camera and subject, it will not throw off the AF. The exposure is set at the moment of exposure.</p> <p>When you use AI Servo AF, you can toggle between AI Servo AF and focus lock just by pressing the < * > button. This is useful for subjects which keep moving and stopping repeatedly. The exposure is also set at the moment when the picture is taken. Thus, the focusing and exposure are always set correctly and all you do is wait for the right moment to capture the shot.</p>	80 36

Custom Function	No.	Setting	Description
Shutter speed and aperture setting method in the Manual mode	CF-5	0	Enables the <  > dial to set the shutter speed and the <  > dial (or the <  > button and <  > dial) to set the aperture.
		1	Enables the <  > dial to set the aperture and the <  > dial (or the <  > button and <  > dial) to set the shutter speed. <ul style="list-style-type: none"> This reverses the functions of the <  > and <  > dials.
		2	The shutter speed and aperture are set in the same way as setting 0. In the aperture-priority AE and manual exposure modes, the aperture can be set with the camera manually even with the lens detached.
		3	The shutter speed and aperture are set in the same way as setting 1. In the aperture-priority AE and manual exposure modes, the aperture can be set with the camera manually even with the lens detached.











Remarks	Page
<p>This makes it easier to change the aperture during studio sessions with studio flash units. Also, when AEB is used in the manual exposure mode, the shutter speed can be fixed while only the aperture is shifted for AEB.</p>	74
<p>If you are using a super telephoto lens with more than one EOS-3 body, you can still set the aperture with the camera(s) not attached to the lens. This function is mainly for pro photographer assistants.</p>	67 74
<p>Same as setting 2.</p> <ul style="list-style-type: none">• To use this Custom Function together with Custom Function CF-11, see page 123.	67 74





Custom Function	No.	Setting	Description
Exposure setting increments	CF-6	0	Enables all settings to be set in 1/3-stop increments.
		1	Enables the shutter speed and aperture to be set in full-stop increments, and exposure compensation and flash exposure compensation in 1/3-stop increments.
		2	Enables all exposure settings to be set in half-stop increments.
Electronic manual focusing.	CF-7	0	The lenses listed on the right enable electronic manual focusing after AF operation.
		1	Disables electronic manual focusing after AF operation.
		2	Disables electronic manual focusing at all times.
Frame counter display	CF-8	0	The frame counter counts up.
		1	The frame counter counts down (indicates the remaining number of frames).

Remarks	Page
<p>This is suited for slide films which have a narrow exposure latitude.</p> <p>The shutter speed and aperture can be set in the familiar full-stop increments.</p> <p>Suited for negative films which have a wide exposure latitude.</p>	<p>64 67 74</p> <p>64, 67 74, 78 97, 98</p>
<p>EF 50mm f/1.0L USM, EF 85mm f/1.2L USM, EF 200mm f/1.8L USM, EF 300mm f/2.8L USM, EF 400mm f/2.8L USM, EF 500mm f/4.5L USM, EF 600mm f/4L USM, EF 1200mm f/5.6L USM, EF 28-80mm f/2.8-4L USM.</p> <p>This prevents the focus from being thrown off by inadvertent turning of the focusing ring after One-Shot AF.</p> <p>When this Custom Function is set to 0 or 1 and Custom Function CF-4 is set to 1 or 3 (see page 122), the focusing ring can be used to focus before AF operation. However, this is disabled with this setting.</p> <p>* When this Custom Function is set to 1 or 2, you must first set the lens focus switch to MF (or M) to focus manually.</p>	<p>52</p> <p>52</p>
<p>You can see how many frames are left in the roll.</p>	<p>25</p> <p>26</p>

Custom Function	No.	Setting	Description
AEB sequence and cancellation	CF-9	0	standard exposure, underexposure, overexposure, then automatic cancellation.
		1	standard exposure, underexposure, overexposure, and no automatic cancellation.
		2	Underexposure, standard exposure, overexposure, then automatic cancellation.
		3	Underexposure, standard exposure, overexposure, and no automatic cancellation.
Focusing point flashing mode	CF-10	0	Standard mode <ul style="list-style-type: none"> Flashes when focus is achieved, lights dimly while you press the shutter button halfway after focus is achieved.
		1	No flashing at all.
		2	No flashing after focus is achieved.
		3	Flashes brightly.



Remarks	Page
<p>AEB is not canceled even when the lens is interchanged or when the film is replaced. Therefore you can keep taking AEB shots (with the standard exposure first).</p> <p>You can keep taking AEB shots in this sequence.</p>	78 78 78
<p>This applies during manual focusing point selection and Eye-Control AF. During automatic focusing point selection, the focusing point does not light dimly after focus is achieved.</p> <p>If the flashing of the focusing point is annoying, you can disable it.</p> <p>This disables the focusing point from lighting dimly after focus is achieved.</p> <p>This makes the focusing point easier to see even in bright light.</p>	42 42 42

Custom Function	No.	Setting	Description
Focusing point selection method	CF-11	0	Enables the focusing point to be selected by pressing the  button and turning the  dial and/or  dial. <ul style="list-style-type: none"> • Turn the  dial to select a focusing point on the right or left, and turn the  dial to select a focusing point on the top or bottom.
		1	Enables the focusing point to be selected by pressing the  button and turning the  dial and/or  dial.
		2	Enables the  dial alone to select a left or right focusing point. <ul style="list-style-type: none"> • Setting 1 operations can also be executed.
		3	Enables the focusing point to be selected by pressing the <FEL> button and turning the  dial and/or  dial.
Mirror lockup	CF-12	0	No mirror lockup (normal position).
		1	Sets mirror lockup.

Remarks	Page
	38
<p>The functions of the  button and  button are reversed. This makes the exposure compensation method and aperture setting method (during manual exposure) the same as with the EOS-1.</p>	42
<p>This setting is identical to the EOS-1N's Custom Function CF-11 set to 2 for the left or right focusing point selection method. With this setting, you can select the focusing point while pressing the shutter button halfway (or within  after releasing the shutter button) or during continuous shooting in the AI Servo AF mode. The focusing point selection stops at the extreme left or right focusing point.</p> <ul style="list-style-type: none"> • During autofocus, pressing the  button switches the focusing point selection mode from manual to automatic. This is convenient when you want to switch quickly to automatic focusing point selection. 	36 42
<p>This reverses the functions between the  button and <FEL> button. The button next to the AE lock button then functions as an <FEL> button.</p>	42
<p>Effective for close-up shots and with super telephoto lenses. Mirror lockup eliminates camera vibration caused by the mirror's reflex action. A tripod is required.</p>	89

Custom Function	No.	Setting	Description
Focusing point and spot metering linkage	CF-13	0	No linkage. • Spot metering is always at the center.
		1	Links spot metering to the focusing point. • Spot metering is linked to one of 11 focusing points selected either manually or by Eye Control.
		2	No linkage. • Spot metering is always at the center. • You can select only one of 11 focusing points.
Automatic reduction of fill-in flash output	CF-14	0	Enable.
		1	Disable.
Shutter curtain synchronization	CF-15	0	First-curtain synchronization. • The flash fires immediately after the shutter opens.
		1	Second-curtain synchronization. • At slow sync speeds, the flash fires immediately before the shutter closes.

Remarks	Page
<p>The selectable focusing points are limited to 11. This makes focusing point selection faster and links spot metering to the focusing point you select. This setting is effective for spotlighted subjects on-stage, etc., when you want to maintain the framing of the subject.</p>	<p>56 96</p>
<p>Compared to setting 0, this setting makes focusing point selection faster. (When automatic focusing point selection is used with settings 1 and 2, all 45 focusing points will be subject to automatic selection.)</p>	<p>56</p>
<p>Natural-looking fill-in flash effects are obtained automatically.</p> <p>Preventing automatic reduction of flash output is effective for backlit subjects in front of a sunset, etc., to prevent underexposure of the subject.</p>	<p>100</p>
<p>By using a slow sync speed, you can create a light trail following a moving subject.</p> <p>* This setting works with Speedlites 380EX and 220EX. (This is effective for EX-series Speedlites which do not have shutter-curtain synchronization switching capability. Speedlite 550EX has this capability and its shutter-curtain synchronization setting overrides Custom Function CF-15.)</p>	

Custom Function	No.	Setting	Description
Safety shift	CF-16	0 1	Disabled. Enabled. <ul style="list-style-type: none"> Safety shift works in the shutter speed-priority AE and aperture-priority AE modes. If a standard exposure cannot be obtained with the shutter speed or aperture you have set, then the camera automatically shifts the shutter speed or aperture so that a standard exposure can be obtained.
Manual focusing point selection range	CF-17	0 1 2	Standard  Expanded selection range  Automatically-selected range 

Remarks	Page
<p>Even if the exposure settings you have set are not suitable, the camera will automatically alter the settings to obtain a standard exposure. This feature is convenient when the scene's brightness changes suddenly.</p>	64 67
<p>The focusing point selection range expands by one point all around the manually-selected focusing point. This setting is effective when the manually-selected focusing point is unable to focus track a subject moving irregularly.</p> <p>The camera automatically sets this focusing point selection range to suit the lens focal length and the subject's movement during predictive AF. This is effective when the subject's movement is unpredictable.</p>	

Using Custom Functions CF-4 and CF-7 Together

If Custom Functions CF-4 and CF-7 are used together, the availability of electronic manual focusing will be as follows:

Custom Function No.	CF-4		
	Setting	0, 2	1, 3
CF-7	0	x / O	O / O
	1	x / x	O / x
	2	x / x	x / x































Before focus/After focus

O: Electronic manual focusing enabled.

x: Electronic manual focusing disabled.

Using Custom Functions CF-5 and CF-11 Together



If Custom Functions CF-5 and CF-11 are used together in the manual exposure mode, the shutter speed and aperture setting method will be as follows:

Custom Function No.	CF-5		
	Setting	0, 2	1, 3
CF-11	0	Shutter speed: Set with <  > dial. Aperture: (1) Set with <  > dial, (2) Or with <  > button and <  > dial.	Aperture: Set with <  > dial. Shutter speed: (1) Set with <  > dial, (2) Or with <  > button and <  > dial.
	1	Shutter speed: Set with <  > dial. Aperture: (1) Set with <  > dial, (2) Or with <  > button and <  > dial.	Aperture: Set with <  > dial. Shutter speed: (1) Set with <  > dial, (2) Or with <  > button and <  > dial.
	2	Shutter speed: Set with <  > dial. Aperture: (1) Set with <  > button and <  > dial.	Aperture: Set with <  > dial. Shutter speed: (1) Set with <  > button and <  > dial.
	3	Shutter speed: Set with <  > dial. Aperture: (1) Set with <  > dial, (2) Or with <  > button and <  > dial.	Aperture: Set with <  > dial. Shutter speed: (1) Set with <  > dial, (2) Or with <  > button and <  > dial.

3. Index of Custom Functions

Film Transport Custom Functions	No.	Setting
① No auto film rewind.	CF-1	1, 3
② High-speed film rewind.	CF-1	0, 1
③ Quiet film rewind.	CF-1	2, 3
④ Leave out film leader after rewind.	CF-2	1
⑤ Set film speed manually.	CF-3	1
⑥ Display remaining frame No.	CF-8	1

AF Custom Functions	No.	Setting
① No AF operation with halfway pressing of shutter button.	CF-4	1, 3
② Autofocus with a button other than the shutter button.	CF-4	1, 3
③ Separate metering and autofocusing operations.	CF-4	1, 3
④ Enable AF lock in AI Servo AF mode.	CF-4	2, 3
⑤ Enable AE and AI Servo AF with the < * > button and allow the shutter button to only release the shutter.	CF-4	3
⑥ After focus is achieved in the One-Shot AF mode, enable electronic manual focusing.	CF-7	0
⑦ After focus is achieved in the One-Shot AF mode, disable electronic manual focusing.	CF-7	1, 2
⑧ Disable focusing point flashing.	CF-10	1
⑨ Enable focusing point flashing only when focus is achieved.	CF-10	2
⑩ Make focusing point flashing brighter.	CF-10	3
⑪ Enable instant switching from manual to automatic focusing point selection.	CF-11	2
⑫ Enable a left or right focusing point to be selected with the < ○ > dial alone.	CF-11	2

Picture-Taking Custom Functions	No.	Setting
① Enable the <  > dial to set the aperture in manual exposure mode.	CF-5	1, 3
② Enable the aperture to be set with the camera even with the lens detached.	CF-5	2, 3
③ Set the shutter speed and aperture increments to full stops.	CF-6	1
④ Set the exposure compensation (including flash exposure compensation) increments to half stops.	CF-6	2
⑤ Prevent AEB from canceling when the lens is interchanged or when film is replaced.	CF-9	1, 3
⑥ Set the AEB sequence to underexposure, standard exposure, and overexposure.	CF-9	2, 3
⑦ Link spot metering to the focusing point.	CF-13	1
⑧ Enable faster focusing point selection.	CF-13	1, 2
⑨ In the shutter speed-priority AE mode, enable a standard exposure automatically even when the lighting conditions change suddenly.	CF-16	1
⑩ In the aperture-priority AE mode, enable a standard exposure automatically even when the lighting conditions change suddenly.	CF-16	1
⑪ Set second-curtain flash synchronization.	CF-15	1
⑫ Enable flash exposure lock with the <  > button.	CF-11	3
⑬ Enable flash exposure bracketing with studio flash.	CF-5	1, 3
⑭ Set a correct flash exposure for a subject backlit by a sunset. (Disable automatic reduction of flash output.)	CF-14	1
⑮ Set mirror lockup.	CF-12	1

The image was removed due to
copyright restrictions

Reference Section

This section helps you understand your camera and enjoy photography better. It gives reference information and introduces system accessories.







1. Troubleshooting Guide

If there is a problem, first refer to this Troubleshooting Guide. If the problem still persists, take the camera to your nearest Canon Service Center. Canon Service Centers are listed on the back of this booklet.

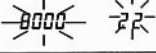
Problem	Probable Cause	Solution	Page
Nothing is displayed on the LCD panel.	No battery has been installed.	Set the <Fn> switch to A .	16
	The battery is exhausted.	Replace the battery with a new one.	21 22
	The battery has been installed incorrectly.	Load the battery correctly.	21
The film does not load.	<Fn> is not on.	Set the <Fn> switch to A .	16
	Film has not been loaded properly. (--- blinks on the LCD panel.)	Load the film correctly.	24 25
A Custom Function cannot be set.	The <Fn> switch is not on.	Set the <Fn> switch to A .	16
	The <Fn> switch has been set to I .	Set the <Fn> switch to I .	19
AF does not work.	<Fn> switch is not on.	Set the <Fn> switch to A .	16
	The lens focus mode has been set to MF (or M).	Set the lens focus mode to AF (or A).	23
	Custom Function CF-4 has been set to 1 or 3.	Set Custom Function CF-4 to 0.	104

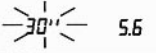
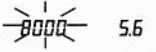
Problem	Probable Cause	Solution	Page
The shutter does not release.	The film has not been loaded properly. (<---> blinks on the LCD panel.)	Load the film correctly.	24 25
	Rewound film is still in the camera. (The <@> icon is blinking.)	Replace the film with a new roll.	24 28
	Focus has not been achieved. (The in-focus indicator in the viewfinder is blinking.)	Press the shutter button halfway again and focus again. If the camera still cannot focus, see "Manual Focusing " on page 52.	17 30 52
The film does not rewind automatically.	The temperature is cold.	Cold temperatures can quickly degrade battery performance. Replace with a new battery.	8 21
	Custom Function CF-1 has been set to 1 or 3.	Set Custom Function CF-1 to 0 or 2.	28 104
"bc" blinks on the LCD panel.	Battery power is very low.	Replace the battery with a new one.	7 21
	A misoperation has occurred with the camera, lens, or flash unit.	Remove and reload the battery. If "bc" turns off, camera operation will be normal. • If "bc" still continues to blink, the camera, lens, or flash unit is faulty. Take the camera and any attached lens and flash unit to your nearest Canon Service Center.	7 21 Back cover

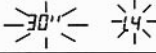
2. Exposure Warning List

Mode and Dial Icon	Blinking Warning	Description	Countermeasures
P	30" shutter speed and maximum aperture 	The subject is too dark.	Use flash.
	8000 shutter speed and minimum aperture 	The subject is too bright.	Attach a neutral density filter to the lens.
Tv	Maximum aperture 125 	The picture will be underexposed.	Set a slower shutter speed.
	Minimum aperture 125 	The picture will be overexposed.	Set a faster shutter speed.
Av	30" shutter speed 	The picture will be underexposed.	Set a larger aperture (smaller f-number).
	8000 shutter speed 	The picture will be overexposed.	Set a smaller aperture (larger f-number).
DEP	Current aperture 6.0 	The desired depth of field cannot be obtained.	1) Move away from the subject and try again. 2) If a zoom lens is used, use the shortest focal length.
	30" shutter speed and maximum aperture 	The subject is too dark.	Use flash.
	8000 shutter speed and minimum aperture 	The subject is too bright.	Attach a neutral density (ND) filter to the lens.

3. Program Line

The program line below applies when the camera is used in the Program AE (P) mode with an EF 50mm f/1.4 USM lens.

Intelligent Program AE Line
With EF 50mm f/1.4 USM

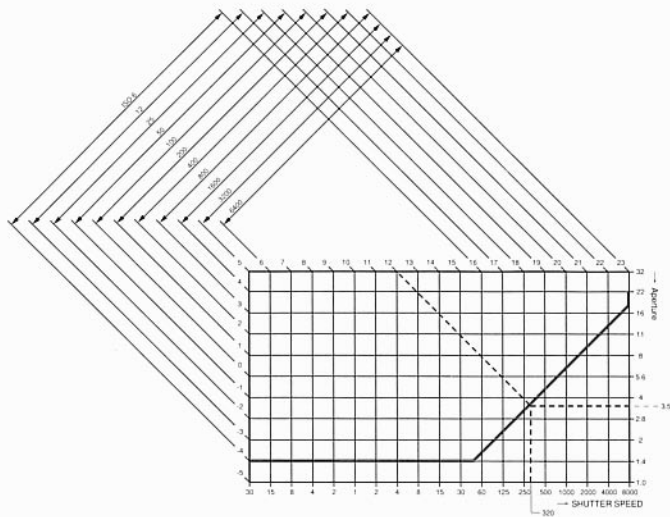

Program Line Description

The bottom horizontal axis represents the shutter speed and the right vertical axis represents the aperture. On the left edge and top edge of the graph, the Exposure Value (EV) is indicated on a 45-degree scale. The program line indicates the shutter speed and aperture which the Program AE mode sets automatically for the respective EV.

Example: When the subject brightness is EV 12, the point where the diagonal line from EV 12 (on the top edge of the graph) intersects the program line indicates the corresponding shutter speed (1/320 sec.) and aperture (f/3.5) which the program sets automatically.

The arrowhead lines above the graph indicate the metering range for the respective film speed.

4. Shutter Speed and Aperture Readouts

● Shutter speed readout

The shutter speed is normally displayed in 1/3-stop increments. Numbers from "4" to "8000" denote the denominator of the shutter speed fraction. For example, "125" is 1/125 sec. Also, 0"3 is 0.3 sec., and 15" is 15 sec.

● Aperture readout

The aperture is normally displayed in 1/3-stop increments. The larger the number, the smaller the aperture opening. The range of aperture numbers (f-numbers) displayed depends on the lens used.

CF

Custom Function CF-6 enables the shutter speed and aperture to be set in full-stop or half-stop increments. See page 112.

1/3-stop Increments		Half-stop Increments		Full-stop Increments			
Shutter speed	Aperture	Shutter speed	Aperture	Shutter speed	Aperture		
8000	13	1.0	2.5	8000	1"	1.0	1.0
6400	10	1.1	2.9	6000	1"5	1.2	1.4
5000	8	1.2	3.2	4000	2"	1.4	2.0
4000	6	1.4	3.6	3000	3"	1.8	2.8
3200	5	1.6	4.0	2000	4"	2.0	4.0
2500	4	1.8	4.5	1500	6"	2.5	5.6
2000	0"3	2.0	5.1	1000	8"	2.8	8.0
1600	0"4	2.2	5.7	750	10"	3.5	11
1250	0"5	2.5	6.4	500	15"	4.0	16
1000	0"6	2.8	7.2	350	20"	4.5	22
800	0"8	3.2	8.1	250	30"	5.6	32
640	1"	3.5	9.1	180		6.7	45
500	1"3	4.0		125		8.0	64
400	1"6	4.5		90		9.5	91
320	2"	5.0		60		11	
250	2"5	5.6		45		13	4"
200	3"2	6.3		30		16	8"
160	4"	7.1		20		19	15"
125	5"	8.0		15		22	30"
100	6"	9.0		10		27	
80	8"	10		8		32	
60	10"	11		6		38	
50	13"	13		4		45	
40	15"	14		0"3		54	
30	20"	16		0"5		64	
25	25"	18		0"7		76	
20	30"	20				91	
15		22					

5. Interchanging the Focusing Screen

The camera's focusing screen can be interchanged to suit the picture-taking application. You must also set Custom Function CF-0 so that the standard exposure standard suits the focusing screen.

Focusing Screen Type	Screen Designation	Custom Function CF-0 Setting
N : New Laser-matte Screen	Ec-N, Ec-R	0
L : Laser-matte Screen	Ec type (A, B, C, CII, D, H, I, L)	1

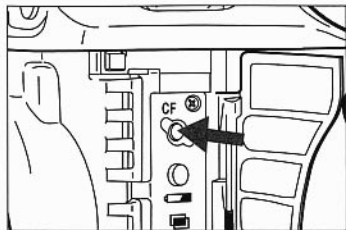

- 1 Open the side door and press the **<CF>** button.
 - The Custom Function No. appears.
- 2 Turn the  dial until "**F- \square** " appears.
- 3 Press the **<CF>** button for 2 seconds. Either " **\square** " or "**!**" will be displayed on the LCD panel. Pressing the **<CF>** button toggles between **\square** and **!**.
- 4 Press the shutter button halfway. The LCD panel's normal display reappears.



- If you do not replace the focusing screen that came with the camera, you need not change Custom Function CF-0's setting.
- To change the focusing screen, refer to the Instructions that comes with the focusing screen.
- The Ec-A, Ec-B, Ec-I, and Ec-L focusing screens has a prism at the center. This prism cannot obtain standard exposure readings during evaluative and spot metering. Use centerweighted averaging metering or off-center spot metering instead.

Interchanging the Focusing Screen

Ec-series Interchangeable Focusing Screens

Ec-A: Standard microprism

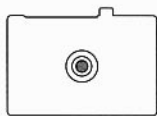

Compatible with all EF lenses. Lenses with a maximum aperture smaller than $f/5.6$ will cause the focusing screen's microprism to darken.

Ec-D: Laser-matte with grid

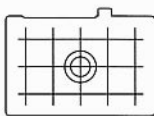

Compatible with all EF lenses. Ideal for architectural photography and photo duplication work.

Ec-B: New split screen

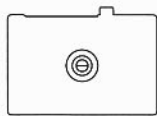

Compatible with all EF lenses. Lenses with a maximum aperture smaller than $f/5.6$ will cause the focusing screen's microprism to darken.

Ec-H: Laser-matte with scale

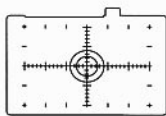

Compatible with all EF lenses. The scales at the center and periphery help you compose shots for close-ups and photomicrography.

Ec-C: Laser-matte

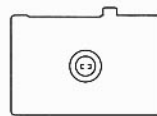

EOS-1's standard screen.

Ec-I: Laser-matte with cross hair reticle

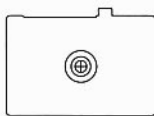

Use the cross hair at the center to focus. Suited for photomicrography and astrophotography.

Ec-CII: Laser-matte

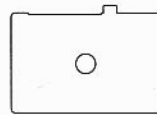

EOS-1N's standard screen.

Ec-L: Cross split screen

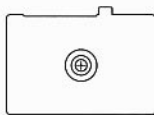

Compatible with all EF lenses. Focus with the vertical and horizontal splits. Lenses with a maximum aperture smaller than $f/5.6$ will cause the focusing screen's split portion to darken.

Ec-R New Laser-matte

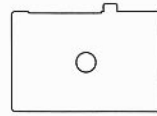

EOS-1N RS's standard screen.

6. Major Accessories



● Camera Case EH-11L and EH-11LL

Dedicated, semi-hard case which can accommodate the camera attached with a lens.

Standard lenses

EH-11L: EF 28-105mm f/3.5-4.5 USM

EH-11LL: EF 28-135mm f/3.5-5.6 IS USM



● Power Drive Booster PB-E2

Together with the Ni-MH Pack NP-E2, Power Drive Booster PB-E2 enables a top continuous shooting speed of about 7 frames per second. The vertical grip has its own shutter button, Main Dial, AE lock button, FE lock button, and focusing point selector. It makes vertical shots as easy as horizontal shots. With Battery Magazine BM-E2, this Booster becomes compatible with the EOS-1N and EOS-1.



● Power Drive Booster E1

Although this was developed for the EOS-1N and EOS-1, it can also be used with the EOS-3. The maximum continuous shooting speed is about 6 frames per second. It has a vertical-grip shutter button and AE lock button.



● Battery Pack BP-E1

The grip portion houses a 2CR5 lithium battery while the battery magazine holds four widely-available size-AA alkaline batteries. You can switch between these two power sources to suit the shooting condition. The continuous shooting speed is the same as a plain EOS-3.



● Ni-MH Pack NP-E2

Powerful battery pack dedicated to Power Drive Booster PB-E2. The rated voltage is 12 V. It can be recharged over 500 times. When fully charged, it has enough power for 70 rolls of 36-exposure film at 20°C.

- * Power Drive Booster PB-E2 installed with this Pack cannot be used with the EOS-1N and EOS-1.



● Ni-MH Charger NC-E2

This dedicated charger quickly recharges the Ni-MH Pack NP-E2, taking about 100 minutes for one Pack. It also prevent excess recharging. Two Packs can be attached at one time. The discharge feature (taking about 8.5 hours) cancels the NP-E2 memory effect. It runs on 100 - 240 VAC.

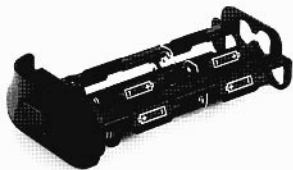

● Battery Magazine BM-E2

Dedicated to and provided with Power Drive Booster PB-E2. It holds eight size-AA alkaline, Ni-Cd, or lithium batteries.



● EX-series Speedlites 550EX, 380EX, and 220EX

Three EOS-dedicated E-TTL autoflash Speedlites are available. The 550EX for a large flash output, the 380EX for affordable performance, and the 220EX for compactness. Their respective Guide numbers (at ISO 100 in meters) are 55, 38, and 22. All three Speedlites enable E-TTL autoflash, high-speed sync (FP flash), and FE lock. With the 550EX, an easy-to-use wireless, multi-flash system is possible.



● Speedlite Transmitter ST-E2

This is the controller for a wireless, multi-flash E-TTL autoflash system. It can control up to two Speedlite 550EX groups set as slaves. The wireless transmitter range is about 12 to 15 meters indoors and 8 to 10 meters outdoors.



● Off-Camera Shoe Cord 2

This cord enables the 550EX to be connected off-camera up to 60 cm away. All of the Speedlite's controls and features can be used as usual. The Cord can be used with all EX-series, EZ-series, and E-series Canon Speedlites.



● Date Back DB-E2

This is an interchangeable, EOS-3-dedicated camera back equipped with a Quick Control Dial and date imprinting feature. The date up to the year 2019 can be imprinted on the photograph. The following imprinting modes (displayed on LCD) are provided: Year, month, day; Day, hour, minute; Blank; Month, day, year; and Day, month, year.

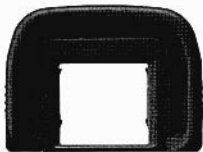

● Ed-Series Dioptric Adjustment Lenses

The EOS-3's viewfinder is set to -1 diopter. If necessary, one of ten Ed-series dioptic adjustment lenses (-4 to +3 diopters) with eyecup can be attached. Eye Control can also be used while a dioptic adjustment lens is attached.



● Timer Remote Controller TC-80N3

This is a remote switch with an 80-cm cord and self-timer, interval timer, long-exposure timer, and other features. The time setting can be set anywhere from 1 sec. to 99 hours, 59 min., 59 sec. Its connection plug for the EOS-3 has a quick-lock feature.



● Remote Switch RS-80N3

Remote switch with an 80-cm cord to prevent camera shake for super telephoto shots, macrophotography, and bulb exposures. The remote switch can give the same effect as pressing the shutter button halfway or completely. It also has a shutter release lock. Its quick-lock plug connects to the EOS-3's remote control socket.



● Extension Cord ET-1000N3

Ten-meter extension cord for connecting the Timer Remote Controller TC-80N3 or Remote Switch RS-80N3 to the EOS-3. For remote picture-taking situations.



● Wireless Controller LC-4

Wireless controller effective up to 100 meters. It comes with a transmitter and receiver. The receiver's camera connection plug connects to the EOS-3's three-pin remote control socket with quick-lock feature. It has the same wireless controller features as the LC-3.







● Remote Switch Adapter RA-N3

This plug adapter enables old Remote Switches (60T3, etc.) having a threaded, 3-pin plug to be connected to the EOS-3's new remote control socket.



- The EOS-3's three-pin remote control socket is new with a quick-lock feature. It is compatible with the new Remote Switch RS-80N3, Timer Remote Controller TC-80N3, and Wireless Controller LC-4 receiver. When a plug is connected, it locks automatically.
- The EOS-3's three-pin remote control socket is not directly compatible with old-model accessories such as Remote Switch 60T3. Remote Switch Adapter RA-N3 will be required to connect such accessories.

Major Specifications

<p>■ Type</p> <p>Type:</p> <p>Picture size:</p> <p>Compatible lenses:</p> <p>Lens mount:</p>	<p>35mm AF/AE single-lens reflex with focal-plane shutter and built-in motor drive.</p> <p>24 mm × 36 mm</p> <p>Canon EF lenses</p> <p>Canon EF mount</p>
<p>■ Viewfinder</p> <p>Type:</p> <p>Picture coverage:</p> <p>Magnification:</p> <p>Standard diopter:</p> <p>Focusing screen:</p> <p>Mirror:</p> <p>Viewfinder information:</p> <p>Depth-of-field Preview:</p>	<p>Eye-level pentaprism</p> <p>97 percent vertically and horizontally</p> <p>0.72x (−1 diopter with 50mm lens at infinity)</p> <p>−1 diopter. (19.5mm eye relief)</p> <p>Interchangeable (9 types), Standard focusing screen: Ec-N.</p> <p>Quick-return half mirror (Transmission:reflection ratio of 37:63). No vignetting with EF 1200mm f/5.6 lens or a shorter lens.</p> <p>(1) On the screen: Area AF ellipse, center spot metering circle</p> <p>(2) Below the screen: Shutter speed, aperture, * (blinks at 2 Hz during AE lock and AEB),  (lights when Eye Control is enabled or blinks when Eye Control fails),  (lights during flash-ready and blinks during unsuitable FE lock),  (lights during high sync speed),  (exposure compensation and flash exposure compensation), ● (in-focus indicator (Light when focus is achieved and blinks at 8 Hz if AF fails))</p> <p>(3) Right of screen: Exposure level scale (±3 stops in ±1/3-stop increments), exposure level indicator (① AE mode and exposure compensation amount, ② AE lock and real-time metering indicator, ③ Manual exposure level, ④ AEB amount, ⑤ Background exposure with flash), flash exposure level (① Flash exposure compensation amount, ① Reverse highlight with FE lock, ① FEB amount), Multi-spot metering, frame counter.</p> <p>Enabled with depth-of-field preview button</p>

■ Exposure Control	
Metering modes:	<p>TTL max. aperture metering with a 21-zone silicon photocell.</p> <ol style="list-style-type: none"> (1) Evaluative metering (linkable to any focusing point) (2) Partial metering (approx. 8.5% of viewfinder at center) (3) Center spot metering (approx. 2.4% of viewfinder at center) (4) Spot metering (linked to focusing point at approx. 2.4% of viewfinder) <ul style="list-style-type: none"> • During continuous shooting with metering modes (3) and (4), the first shot is metered in real time and the meter reading is locked (AE lock) for subsequent shots in the same burst. (5) Multi-spot metering (Max. 8 multi-spot metering entries) (6) Centerweighted averaging metering
Exposure Control Methods:	<ol style="list-style-type: none"> ① Program AE (shiftable), ② Shutter speed-priority AE (in 1/3 stops, safety shift enabled with Custom Function), ③ Aperture-priority AE (in 1/3 stops, safety shift enabled with Custom Function), ④ Depth-of-field AE, ⑤ E-TTL program flash AE (high-speed sync, FE lock, and wireless control enabled with 550EX), ⑥ A-TTL program flash AE, ⑦ TTL program flash AE, ⑧ Manual, ⑨ Bulb
Metering range:	EV 0-20 (at 20°C with 50mm f/1.4 lens, ISO 100)
ISO film speed range:	ISO 6-6400 (Set automatically with DX-coded film at ISO 25-5000.)
Exposure compensation:	<ol style="list-style-type: none"> (1) Autoexposure bracketing (AEB): ± 3 stops in 1/3-stop increments. standard exposure, underexposure, and overexposure sequence. Repeated bracketing enabled according to current film advance mode. With self-timer, all three bracketed shots are taken in the continuous shooting mode regardless the film advance mode. (2) Manual exposure compensation: ± 3 stops in 1/3-stop increments set with the Quick Control Dial or exposure compensation button and Main Dial. (3) AEB and manual exposure compensation can be set together.
AE Lock:	<ol style="list-style-type: none"> (1) Auto AE lock: Operates in One-Shot AF mode with evaluative metering when focus is achieved. (2) Manual AE lock: AE lock button activates AE lock in all metering modes.

Major Specifications

Multiple exposures:	Max. 9 multiple exposures. Cancels automatically after all multiple exposures are taken. (Cancelable and resettable at any time.)
■ AF Type: Focusing points: AF working range: Focusing modes: In-focus indicator: Focusing point selection: AF focusing point indicator: AF-assist beam:	TTL-AREA-SIR with a CMOS sensor Area AF with 45 focusing points (Custom Function can limit this to 11) EV 0-18 (at ISO 100) (1) One-Shot AF: Autofocus stops when focus is achieved. AF lock enabled. Shutter releases only when focus is achieved. (2) Predictive AF with AI Servo AF: Tracks subject movement up to the start of exposure. Predictive AF enabled. The shutter can be released at anytime regardless of focus (predictive AF control takes effect during continuous shooting), no in-focus indicator (blinks at 8 Hz only if AF fails). (3) Manual focusing: Enabled with the focusing ring when the lens focus mode is set to MF (or M). (4) Manual focusing: Enabled with the electronic focusing ring during continuous shooting (except during film exposure). Lights in viewfinder (●) and beeps. (Beeper can be disabled.). (1) Automatic selection: Focusing point camera-selected. (2) Manual selection: Focusing point manually-selected. (3) Eye-Control selection: Focusing point eye-selected. Superimposed focusing point in viewfinder Emitted automatically by the attached EOS Speedlite when necessary.
■ Shutter Type: Shutter speeds: Shutter release: Self-timer:	Vertical-travel, focal-plane shutter with all speeds electronically-controlled. 30 to 1/8000 sec. in 1/3-stops, X-sync at 1/200 sec. Soft-touch electromagnetic release Electronically-controlled with 10-sec. or 2-sec. delay. Lamp blinks (2 Hz, then 8 Hz for the remaining two sec.). Self-timer countdown on LCD panel. Self-timer cancelable by turning the main switch to L.

<p>■ Film Transport</p> <p>Film loading:</p> <p>Film advance system:</p> <p>Shooting capacity:</p> <p>Film rewind system:</p> <p>Film rewind time:</p> <p>Rewind noise:</p>	<p>Automatic loading with a sprocketless system. After film is loaded and the back is closed, the film advances to frame 1 automatically, taking about 1 sec.</p> <p>Automatic film advance with built-in motor.</p> <p>(1) EOS 3: Single <input type="checkbox"/> and continuous <input checked="" type="checkbox"/> shooting.</p> <p>(2) With Power Drive Booster PB-E2: Single <input type="checkbox"/>, low continuous <input checked="" type="checkbox"/>L, and high continuous <input checked="" type="checkbox"/>H.</p> <p>No. of 24-ex. rolls / No. of 36-ex. rolls</p> <p>At 20°C: Approx. 75 / Approx. 50 At -20°C: Approx. 18 / Approx. 12</p> <p>While using an EF 50mm f/1.4 USM lens, 1/1000 sec. shutter speed, Eye-Control, and continuous shooting mode, the following operations for each frame were executed: The lens was focused from infinity to the minimum distance and back, the shutter button was pressed halfway for 6 seconds, the picture was taken, and the settings were retained for 2 seconds. This operation cycle was repeated in continuous shooting mode and high-speed film rewind was used at the end of each roll.</p> <p>At the end of the roll, automatic film rewind with a built-in motor. Midroll rewind possible.</p> <p>Approx. 4.5 sec. for 24-ex. film and approx. 6.5 sec. for 36-ex. film</p> <p>59 dB (High-speed rewind), 49 dB (Silent rewind)</p>
<p>■ Camera Specifications</p> <p>Flash contacts:</p> <p>External Flash Unit Compatibility:</p> <p>Custom Functions:</p>	<p>(1) Hot shoe: X-sync direct contacts</p> <p>(2) Below camera back latch: JIS B-type socket (threaded)</p> <ul style="list-style-type: none"> • Flash units connected to (1) and (2) can be used and fired simultaneously. <p>E-TTL autoflash, A-TTL autoflash, TTL autoflash</p> <p>Eighteen user-settable Custom Functions: (0) Focusing screen characteristics, (1) Auto film rewind mode, (2) Film leader position after rewind, (3) Film speed setting method, (4) AF activation method, (5) Manual Tv/Av setting method, (6) Increments for shutter speed, aperture, exposure compensation, flash exposure compensation, and AEB, (7) Manual focusing with electronic focusing ring, (8) Frame</p>

Major Specifications

	counter, (9) AEB sequence, (10) Focusing point superimposed flashing, (11) Focusing point selection method, (12) Mirror lockup, (13) Spot metering linkage to focusing point, (14) Fill-in flash output control, (15) Shutter-curtain flash synchronization, (16) Safety shift for shutter speed priority-AE and aperture-priority AE, (17) Manual focusing point selection range.
LCD panel:	Displays shooting, metering, AF, and film advance modes; shutter speed, aperture, frame counter, and battery level. Illumination provided.
Remote control:	Quick-lock, three-pin remote control connector provided.
Power source:	(1) One 2CR5 lithium battery housed in the camera grip. (2) With Power Drive Booster PB-E2, 8 size-AA alkaline, Ni-Cd, or lithium batteries or Ni-MH Pack NP-E2. (Camera grip removed.) (3) With Battery Pack BP-E1, 1 2CR5 lithium battery and 4 size-AA alkaline or Ni-Cd batteries (Camera grip removed.)
Battery check:	With battery check button pressed, battery level displayed in four levels on LCD panel.
Camera back:	Interchangeable with Dateback DB-E2 (sold separately)
Dimensions:	161 (W) × 119.2 (H) × 70.8 (D) mm 6.3 (W) × 4.7 (H) × 2.8 (D) in.
Weight:	780 g / 27.5 oz. (excluding lithium battery)

- All data are based on Canon's Standard Test Method.
- Subject to change without notice.

Custom Function Symbols

Custom Function No.	Sticker				Custom Function No.	Sticker			
	0	1	2	3		0	1	2	3
CF-0					CF-9				
CF-1					CF-10				
CF-2					CF-11				
CF-3	ISO DX	ISO M			CF-12				
CF-4	•AF •AEL	•AEL •AEAF	•AF •AFL	•AE •AEAF	CF-13				
CF-5	~Tv *Av	~Av *Tv	~Tv *Tv	~Tv *Tv	CF-14				
CF-6	1/3 STEP	1 STEP	1/2 STEP		CF-15				
CF-7	AF MF	AF M	AF		CF-16		SS		
CF-8					CF-17				

- A sticker is provided for the Custom Functions. Affix it to the side door on the inside.
- For details on CustomFunctions, see pages 106 to 121 .

This device complies with Part 15 of the FCC Rules. Operation is subject to the following two conditions: (1) This device may not cause harmful interference, and (2) this device must accept any interference received, including interference that may cause undesired operation.

Do not make any changes or modifications to the equipment unless otherwise specified in the instructions. If such changes or modifications should be made, you could be required to stop operation of the equipment.

This equipment has been tested and found to comply with the limits for a class B digital device, pursuant to part 15 of the FCC Rules. These limits are designed to provide reasonable protection against harmful interference in a residential installation. This equipment generates, uses and can radiate radio frequency energy and, if not installed and used in accordance with the instructions, may cause harmful interference to radio communications.

However, there is no guarantee that interference will not occur in a particular installation. If this equipment does cause harmful interference to radio or television reception, which can be determined by turning the equipment off and on, the user is encouraged to try to correct the interference by one or more of the following measures:

- Reorient or relocate the receiving antenna.
- Increase the separation between the equipment and receiver.
- Consult the dealer or an experienced radio/TV technician for help.

This digital apparatus does not exceed the Class B limits for radio noise emissions from digital apparatus as set out in the interference-causing equipment standard entitled "Digital Apparatus", ICES-003 of the Industry Canada.



The CE Mark is a Directive conformity mark of the European Community (EC)

The image was removed due to
copyright restrictions

Canon

Company information that is no longer current has been removed. If you have any questions regarding this model and are calling from the USA, please call 1 800 OK CANON